

IMPERIAL COLLEGE
EXPEDITION
TO
KENYA (1981)

(Published November 1982)

PART 1

INTRODUCTION

Glenn Harris

1.0 Introduction

During the Summer of 1981, seven undergraduates (four from Imperial) participated in a Hydrological Expedition to Kenya. It was intended to carry out two concurrent projects; a weir calibration and a public health survey. All work was to be carried out on the coast and the entire expedition was intended to last nine weeks. The expedition was discussed and provisionally backed by the Exploration Board at their March 1981 meeting. The members of the expedition were,

Glenn Harris	(Imperial - Leader)
Marek Banasiak	(" - Treasurer)
Jenny Egdell	(")
Nick Jones	(")
Becky Davies	(Bristol Polytechnic)
Niall Craig	(Teeside Polytechnic)
Anne Sullivan	(Durham University)

2.0 Preparations for the trip

2.1 Inspiration

I decided during the Summer of 1980 to try and organise an expedition to Kenya for the following Summer. I had spent a year working there as a volunteer before I came to Imperial, and so knew a little about the country. It was Mr. R. Gray of the Commonwealth Youth Exchange Council who provided the initial inspiration by suggesting that I might be able to organise some sort of trip to Kenya for a group of young people: The rest was obvious!

2.2 Formulating a theme

Having decided that the group just had to be made up of Students, and given that I was studying Civil Engineering, I began writing to various contacts and quizzing members of the department. Eventually, via Miss Shaw of the Hydrology department, I was put in touch with a hydrologist in Kenya who suggested several possible projects. I finally decided on the calibration of the Baricho Weir as it tied in very well with another project I was considering. I was very interested in the effect large civil engineering works in Third World countries had on their local environment, particularly those backed by foreign aid. The Baricho Weir is part of the new Coastal Water Supply Scheme (mostly backed by foreign money) and I thought it might also be possible to run a project studying the effects of the scheme, particularly from the point of view of Third World Development.

/This

This rather hazy idea was refined as the expedition formed up, and it was finally decided also to do a public health survey (study of water and sanitation facilities), in a small area affected by the new scheme on the coast. The basis of this project was formed from material suggested by Prof. Conway (Dept. of Environmental Studies, Imperial College).

2.3 Formulation of a team

In January of 1981 I formed a team of four civil engineers from Imperial and four other undergraduates from other colleges (whom I knew from my year of voluntary work in Kenya). I decided that a team of all civil engineers would not be practical because of the work we intended to do. This was for two reasons. Firstly, the other four had visited Kenya before and so could help combat the logistical problems we would encounter. (I did not feel confident enough in my own abilities to lead a team of complete first-timers to Kenya). Secondly, the success of the public health survey depended largely on the amount and quality of information we could collect, and so a team including people who already had relevant contacts seemed most suited to this task.

Unfortunately, one of the non-Imperial members had to drop out, but this was a few months before we were due to leave and so arrangements could be changed accordingly.

2.4 Sponsorship

It was estimated that the trip would cost £500 per person, and this in the end turned out to be exactly right. Our other main sponsor, apart from the Exploration Board was the Commonwealth Youth Exchange Council who gave us £136 per person. With other smaller grants (e.g. the Holbein travel scholarship) and a personal contribution of £200 from each member, we were easily able to reach our target total before setting off.

We qualified for the C.Y.E.C. grant because we were hoping to collaborate with Civil Engineering students from Nairobi University. This eventually proved impossible as the University was closed down, after riots, a few months before our visit, and then re-opened during our stay. This effectively shifted our contemporaries' summer holiday and so they were unable to join us.

2.5 Making arrangements

Once a team had been formed and a theme decided upon, we were able to get down to researching the trip and making any necessary arrangements.

Firstly, references had to be consulted regarding the work we were planning to do. We were very fortunate to receive the generous attention of several members of the Civil Engineering Department in this respect.

We also visited the offices of Scott, Wilson, Kirkpatrick and Partners, the main consultants on the new water supply scheme. Thanks to contact made via the Exploration Board, we were able to meet one of the senior partners instead of being palmed off with the Public Relations Officer.

Partly as a preparation to living and working together as a group, we all attended a course run by the International Voluntary Service, called "Questioning Development."

All the equipment we took was borrowed from the Exploration Board or the Civil Engineering department. We kept our requirements to a minimum by borrowing more equipment when we arrived in Kenya, thus avoiding any freight charges.

Our flights were arranged by the Imperial College branch of London Student Travel. We were not charged for a flight cancellation and on the whole received very satisfactory service from them.

3.0 The Trip

3.1 Arriving in Nairobi

We flew to Nairobi with Sudan Air on the 23rd July 1981. On arrival we made our way to the headquarters of my former volunteer organisation, where we were allowed to stay during the first week and on any subsequent trips to Nairobi.

Immediately we ran into two snags. Firstly, the weir we had intended to calibrate was not finished due to an industrial dispute, and secondly, the students from Nairobi University we were supposed to liaise with proved very difficult to contact.

Two months before leaving, we had been informed by the consultants that the weir construction was going as planned, and should easily be finished before our arrival. Just after this there was a dispute between the Government of Kenya and the contractor and all work was stopped. To make things worse, armed guards were then placed on duty at the site, to stop the contractor from reclaiming his plant. It did not seem that the dispute would be resolved quickly.

With the help and advice of the consultants, we decided to change our hydrological project to a loss-rating of the Sabaki river, between the Baricho Weir and Malindi. This required the same equipment as we had brought, and happily proved a more useful and enjoyable project than the one originally intended. However, this project would still require access to the Baricho site, and so permission would have to be obtained from the Ministry of Water Development.

We eventually caught up with our contemporaries from Nairobi University and had discussions with them. They agreed to come down and help us for a while and on the day we bought their train tickets President Moi announced the University would be going back the following week. There was no chance of them getting time off as exams were looming, and so the idea of a collaboration unfortunately had to be dropped.

So, the first week was spent in Nairobi visiting various Ministries and offices, mostly trying to see people who were never in, and also collecting various things (e.g. Ordnance Survey maps.) We were supposed to obtain official permission, from the office of the President, to carry out our projects (as all researchers are required to do) but we eventually gave up on this after being subject to much buck-passing. We also tried to obtain official permission to enter the Baricho site from the Ministry of Water Development, but also gave up on this as the letter we were promised never did turn up "tomorrow". We managed to by-pass the need for this bit of paper by entering and leaving the site with the consultant engineer and posing as his assistants.

3.2 Setting up a base.

After a week in Nairobi we all moved down to the coast and set up a base for our work. We rented a house in Kikambala, just north of Mombasa (at half-price thanks to Jenny's engaging smile - engaging being the operative word!), to store all our stuff in and act as a rendezvous place.

The first few days on the coast were spent getting used to the heat and getting in provisions. We also managed to borrow a current meter, from the Ministry of Water Development, far superior to our own which we kept for the whole six weeks work.

Becky, one of the non-Imperial members had been based near Kikambala on her first visit to Kenya, and so she spent the first few days renewing old acquaintances, with a view to getting the public health survey started. She provided many useful contacts in the nearby villages, who in turn provided access to many other study households.

We also made contact with Mr. Andy Scott, the chief site engineer for the consultants, who lived in Malindi. He arranged transport for the hydrologists (Landrover and driver!), provided them with access to the site and also gave lots of good advice (such as - "you would be unlucky if you got bitten by a crocodile!") It was extremely fortunate for us that he was an ex-I C man and a very nice guy as well. Whilst in Malindi we stayed at the Youth Hostel.

3.3 Starting Work

Most of the work was performed during the week, all meeting up at Kikambala at week-ends to discuss the projects and generally recover. At any

one time two or three would be working on the hydrological project, and four or five on the public health survey, all working on a rota-system so that everybody got involved in both projects.

Work, once started, proceeded very smoothly, becoming more interesting as we became more involved. We were very fortunate to become friendly with the public health education officer for the Coastal Province, who provided us with lots of useful information and took us on a few day trips. Mr. Scott also arranged a tour of the complete pipeline for us.

The loss-rating of the Sabaki river involved metering the river at various sections between Baricho and Malindi. This meant that each day we would go to a different stretch of the river (sometimes in very remote places) and try to take two complete sets of readings. While we were there, the river subsided a little and so we got a range of results. A loss-rating is basically an attempt to estimate how much a river "leaks". This is very important for the Sabaki river as down-stream of Baricho it supplies Malindi. Thus, if the treatment works at Baricho is to take the maximum amount of water from the river for Mombasa, it is essential to know the loss-rating to ensure the river does not become dangerously low in the dry season.

The public health survey was much less clear-cut. Basically, we intended to study several small villages, in the rural areas to find out what facilities they had available. Knowing this, we would then try to extrapolate and estimate what changes would take place in the villages as a result of the new Coastal Water Supply Scheme.

We started out by visiting the houses of people we knew in these areas. The actual gathering of information itself proved quite a challenge. How do you find out what each study household does for water and sanitation? If you ask, are they exaggerating? If you observe, is what you see representative? The first day or so at a particular site would be spent just getting to know the locals, looking around giving them a chance to get used to us, making sketch maps. Then we would proceed with our questioning. This part of our work was most fascinating - a real glimpse of how the other half lives.

3.4 Preparations for returning home

Sadly, after six very enjoyable weeks work we had to start tying up our projects and clearing out the house. We then split into two groups for a bit of touring before meeting up again in Nairobi for the flight home. Whilst in Nairobi we said thank you to all those who had helped us.

We all arrived home safe and sound on 27th September 1981. The return journey with Sudan Air was uneventful apart from a little bit of trouble over

/confirming

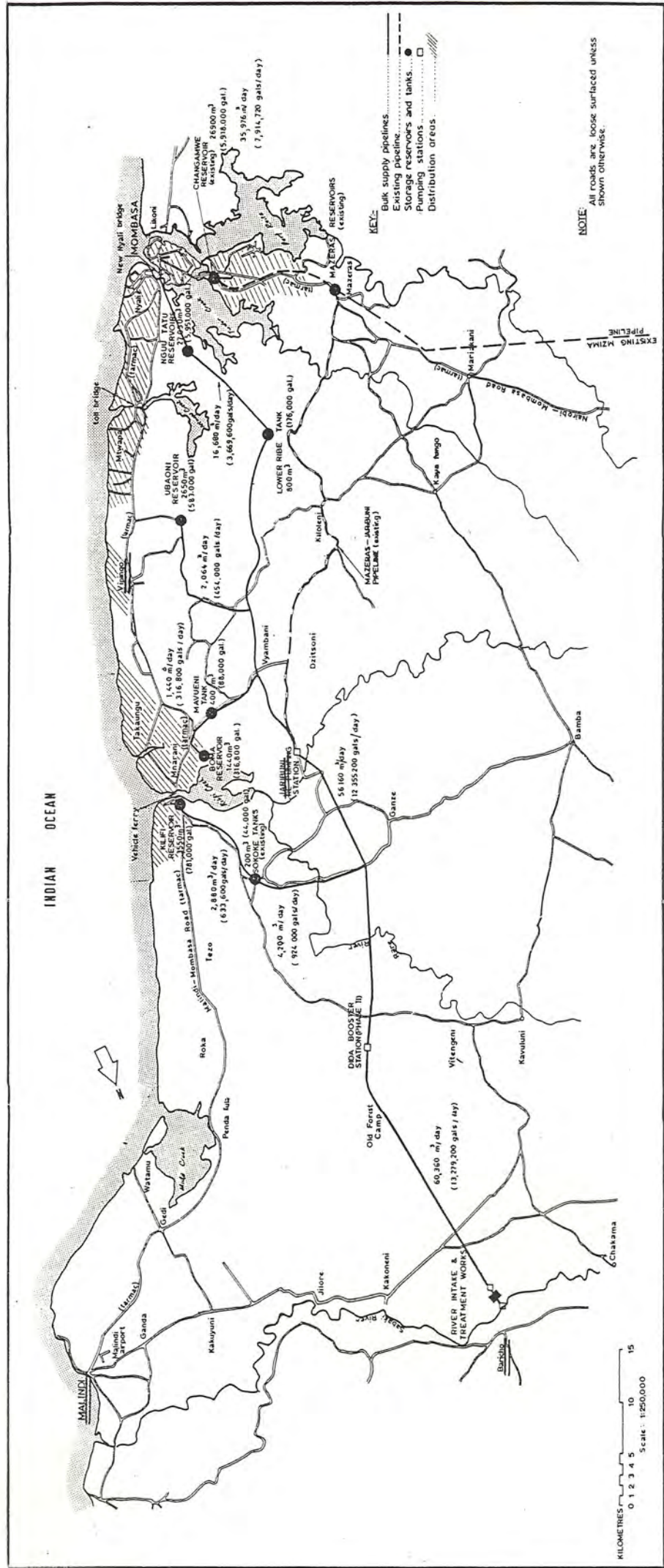

Fig. 1 Study Area

SCHEMATIC LAYOUT OF MOMBASA AND COASTAL WATER SUPPLY PROJECT

SCOTT WILSON KIRKPATRICK AND PARTNERS

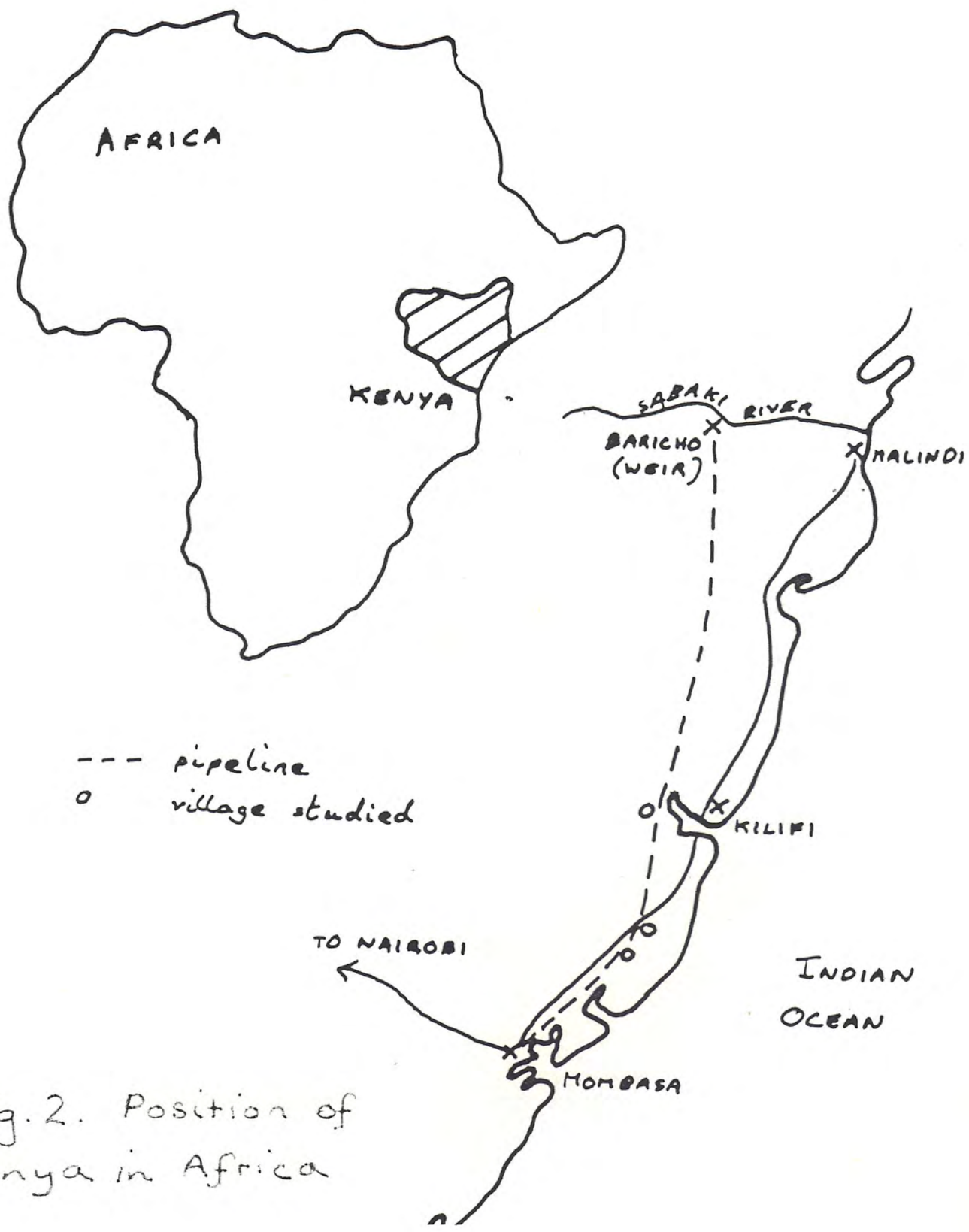

Fig. 2. Position of Kenya in Africa



P. 1. Two methods of transporting water: above by bucket, below by pipeline

confirming bookings. Sudan Air were adequate and cheap.

4.0 Conclusions

4.1 Assessment of Expedition

Every aspect of the trip, apart from the proposed collaboration with students from Nairobi, was a total success. We all learnt an awful lot both about the subjects we studied, and about life in a Third World country. Although our dealings with officials were often frustrating (and very educational), our other contacts proved inspirational.

Most importantly of all, we were able to make friends with people from a different world, and learn an awful lot from them as well as about them.

4.2 Problems encountered.

The expedition was very fortunate not to encounter any serious problems. Apart from our initial Weir and Nairobi University problems things went very smoothly. All members enjoyed excellent health throughout our stay and have all been passed fit in subsequent medical checks.

4.3 Acknowledgements

The team would like to thank all those who helped us, in particular:

Dr. Schroter

and Mr. Addlington, of the Exploration Board

Dr. S. Perry

and Miss Shaw, of the Civil Engineering department

and Mr. A. Scott, of Scott, Wilson, Kirkpatrick and Partners.

PART 11

THE HYDROLOGICAL STUDY

Marek Banasiak

C O N T E N T S

- 1.0 Introduction
- 2.0 Flow Measurements using the current meter
 - 2.1 Selection of the site of measurement
 - 2.2 Creating the control surface
 - 2.3 Taking the measurements
- 3.0 Interpretation of current meter results
 - 3.1 Standard manipulation of each set of results
 - 3.2 Manipulation of the results in special cases
- 4.0 Calculations and results
 - 4.1 General river description
 - 4.2 General features of the project
 - 4.3 The loss rating
 - 4.4 Loss curve
 - 4.5 Accuracy of results and conclusions
- 5.0 Conclusions

APPENDICES

1.0 Introduction

The aim of the project is to use the current metering technique to measure flows on the Sabaki River between Baricho Weir and Malindi and hence to obtain a loss rating for that portion of the river. Information about the flow in the Sabaki River is quite rare especially this far downstream and so a series of such measurements would be a useful addition and assessment of the accuracy of the estimates made for the design of the Baricho Weir and the decision about the possible rates of abstraction. At low flows it is critical that enough water remains in the River between Baricho and the coast to allow for a reasonable abstraction at Malindi, channel losses and a constant flow into the sea.

As well as this we felt this project would be a useful insight and good experience into the technique of current metering and all the aspects of producing an accurate set of results and into a major Civil Engineering Work the Baricho Weir and Mombasa and coast pipeline project, of the type many of us hoped to work on in the future.

2.0 Flow measurement using the current meter

A problem that was to dictate the manner of this procedure was the tolerance of the flow measurement using a current meter with regard to the kind of accuracy we would need to be able to calculate a loss rating. Therefore we emphasised accuracy and precision of the method and its operators, hoping to be able to further improve the accuracy by statistical analysis.

2.1 Selection of the site of measurement

It is important to select a site with conditions that are aligned as far as possible with the assumptions of the calculations. Particular features to note are:

- (i) The stretch of river must be straight with few cross-currents, otherwise a position before the bend is preferable to one after the bend.
- (ii) The stretch of river must not be too deep. The river was metered by wading and a water level higher than chest level and the rod could not be held upright.
- (iii) The stretch of river must not be too wide. The metering would then be too tedious and the marking-out string would not be long enough. This condition conflicts with (ii): a compromise must therefore be found.

The Sabaki River is a particularly variable river with a soft bed and large sediment load. This meant that the river was prone to sudden channels

in its profile. I also felt that a quick flow measurement at any one site would improve the results.

The time of the flow measurement was considered at tidal sites like Malindi Bridge.

2.2 Creating the control surface

The control surface is an abstract concept of a surface which acts as a stationary reference relative to which the water moves used in the calculation. However it was helpful to create such a surface at each site by stretching a string across the river. The string was an orange nylon lightweight fishing line that was suspended about 0.5m above the water surface. The line was knotted at approximate 1m intervals and was suspended taut across the river as perpendicular to the flow at all points as was possible.

Each knot indicates the position of a set of current meter measurement and the string is a straight line and a good reference from which to judge the direction of the velocity.

2.3 Taking the measurements

Measurements were taken from the South bank so that the consistency enabled each set of results to be easily compared. The measurements were of three types: breadth, depth and velocity.

Breadth measurements are taken to pinpoint the position of each knot along the width of the river. Using a tape-measure the distance between every fifth knot was measured and the distance between any odd knots at the end of the string and the distances from each of the banks to the nearest knot. Thus the whole width was measured and the distance from the South bank to each knot can at least be well approximated. A taut string meant no catenary corrections were necessary.

Measurements of depth and velocity were made at each point, working along the string from the South bank. Using the current meter rod the depth was measured before and after each series of velocity measurements so that we would have a back check and an indication of the variability of the river profile.

A full series of velocity measurements is a measurement of the velocity over a 30 second period at depths equal to 2/10, 6/10 and 8/10 of the initial depth. However if the initial depth was less than 0.5m only the velocity measurement at 6/10 of the depth is made. Since the propeller of the current meter has a span of 120 mm the distance between measurements would have any additional ones unhelpful. This also meant that depths less than 0.2m could not be metered and instead a floatation method might be used. Floatation

methods involve measuring the velocity of a float but are very susceptible to inaccuracies.

3.0 Interpretation of current meter results.

Due to the lack of information in codes of practice on loss ratings in Kenya we feel it necessary to set out the way we interpreted our results. This is made all the more critical since the accuracy of the instrument and the accuracy inherent in the metering has not given as clear cut results as might have been hoped for. We therefore wish to know the meaningfulness of applying a statistical analysis to the results.

3.1 Standard manipulation of each set of results.

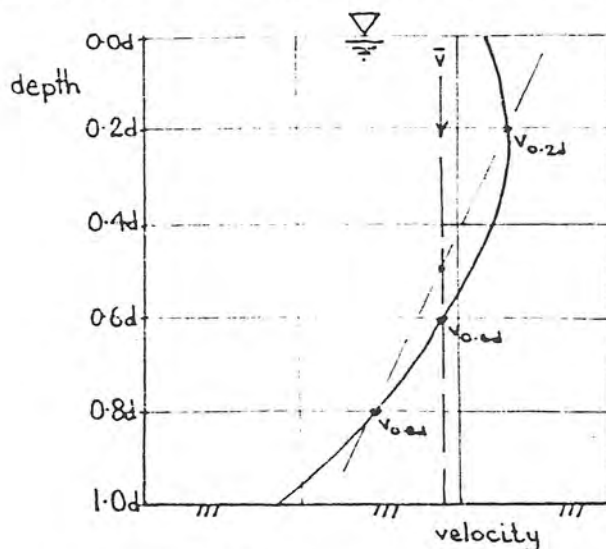

Fig. 1 A typical velocity profile

At each vertical along the cross section we were looking to measure the average velocity of water in that vertical. Two standard estimates for this were (i) simply the water velocity at 0.6 depth and (ii) the average of the water velocities at 0.2 depth and 0.8 depth.

Wherever possible we made both these estimates and simply took the average of both of them even though the second was more reliable and deserved a weighting and some results were quite inconsistent. In general it can be said that the inconsistencies would have decreased the actual value since the rotation of the propeller was more likely to be impeded rather than speeded up.

3.2 Manipulation of the results in special cases

Wherever the depth of the water was less than 20m we would either take no measurements and merely extrapolate over that region using boundary conditions such as zero flow at solid boundaries or the nearest measurement. Otherwise we could use floats to take measurements of the surface velocity. This was extremely unreliable and was only really used in the direst of cases.

/Fortunately

Fortunately these exceptions concerned small flows that were a minor part of the flow as a whole.

Otherwise problems occurred when the flow was not perpendicular to the control surface as defined by the string. In these cases we either estimated the angle of the velocity of the flow in broad terms like 30° , 45° , 60° and 80° and measured accordingly.

The alternative which was extremely unreliable was to keep the current meter perpendicular to the control surface and allow the current meter to make its allowance. We soon discovered that the current meter had been designed to stop when the flow was not parallel to its body and therefore the last method was only used when the velocity deviated slightly.

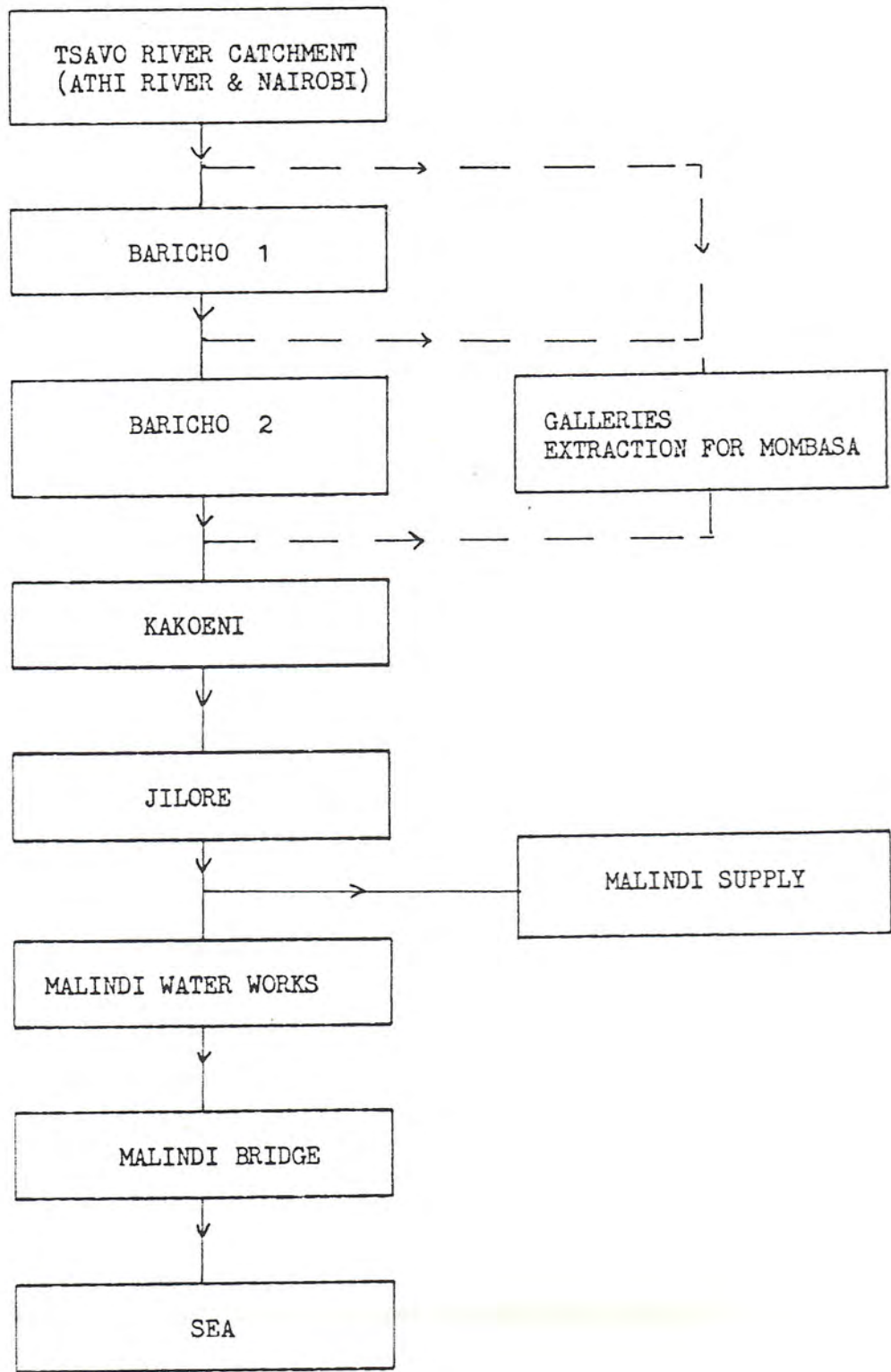
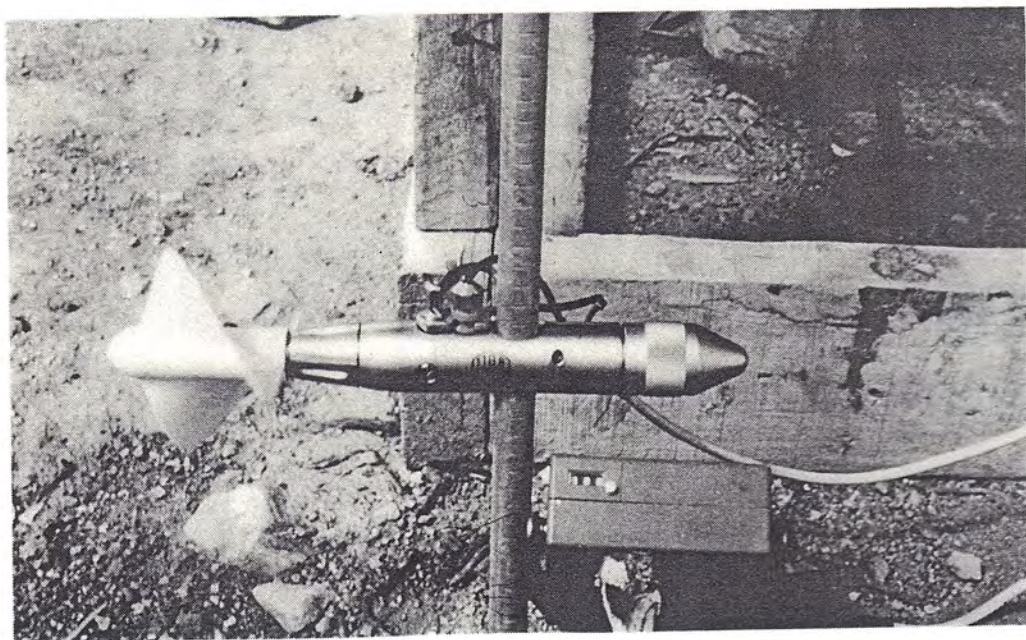

Fig. 2 Flow Chart representing the Hydrological cycle of the Sabaki River.



P.1. Glenn and Marek metering. In the background Malindi Bridge.



P.2. The current meter used.



P.3. Baricho Weir

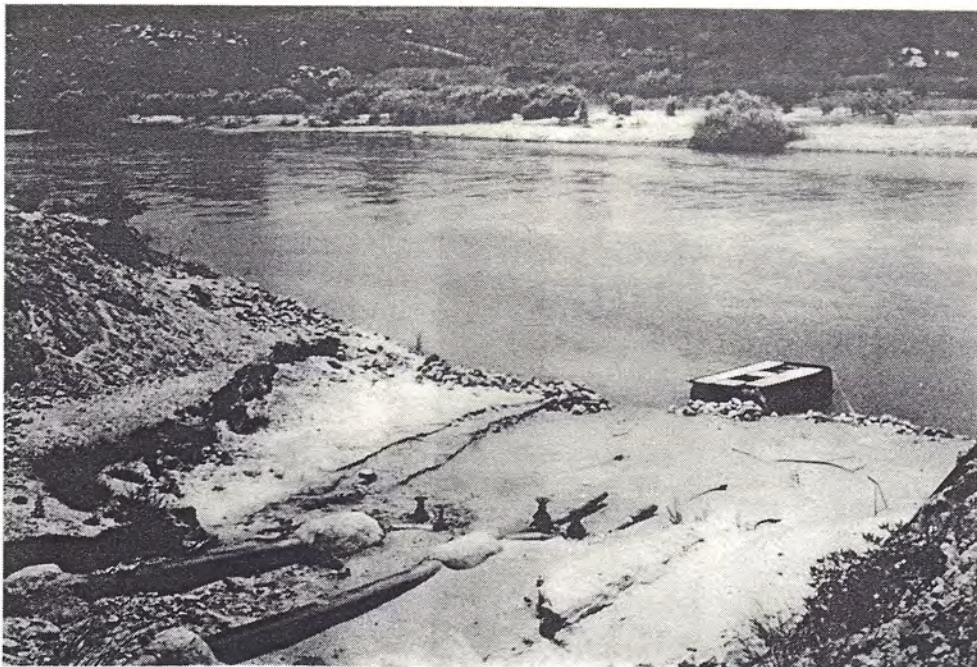

P.4. Metering site at Baricho

4.0 Calculations & Results

4.1 General River Description

The Sabaki River between the Baricho Weir and the Sea is generally a shallow and very wide water course. Its characteristics are largely determined by the single fact that it carries an extremely high sediment load. Compounding this problem is the wide flood plain through which the river flows which consists of compacted sediment which leaves the river banks extremely vulnerable to erosion. In this flood plain the river has developed a very convoluted channel which is constantly changing its position. The river is often very wide, over 100m especially where mud flows of sediment have built up. Sometimes the river also divides up to flow around such a mud bank. Further to its large width the depth of the river is rarely greater than 1.2m or 1.5m but since the bed is so mobile at certain bends deep channels have been scoured out where the main force of the flow has been directed. The water itself is a murky brown colour because of the nature of the sediment and hence such channels can only really be found by falling into them while traversing the river.

The conditions are obviously not very suitable for rigorous scientific measurements. Therefore we incorporated several double checks into the techniques used to monitor the change in the depth and width of the river. In addition we hoped to improve the confidence of our final result by taking a number of readings over a period of time. Fortunately the presence of sediment did mean that there was hardly any plant life in the water and so reduced the real risk of schistosomiasis being caught by any of our intrepid waders.

4.2 General features of the project

The period in which the current metering was performed in the Sabaki River, between the Baricho Weir and Malindi Bridge, was the months of August and September. These are some of the driest months just before the short rains in October and the long rains in April which ought to be the time of low flows in the river when the channel losses are most critical. However there were several days of rain as indicated in the Appendix. 6. Furthermore the stage measurements made by Malindi Water Works shown in Appendix 5 indicate a tendency of continuing reduction in the flow over the period. A quick glance at the flow measurements indicate the magnitude of flows at Baricho Weir and Malindi Water Works as approximately $20 \text{ m}^3/\text{s}$ and $16.5 \text{ m}^3/\text{s}$ respectively. Since the cross sectional area of the river metered at

/Baricho

Baricho Weir on 12th August is known to be 37.10m^2 we can further say that the flow recorded that day of $19.85\text{m}^3/\text{s}$ indicates an average water velocity of $0.535\text{m}/\text{s}$. The gradient between Baricho and the sea is estimated as 1: 1220.

4.3 The Loss Rating

The loss rating can have two forms, both of which we tried to some extent measure: (1) the most general form was simply the loss in flow per metre of river as a constant average between Baricho and Malindi Bridge, (2) the form and extent of this loss at each point along the stretch of river. The former is more useful to the designer and the latter for a deeper understanding about the essence of the areas water flows overground and in the ground.

The problem faced in analysing the data was to make any meaningful comparison between the flows measured on each day, when each day we incurred different conditions. Originally we had hoped to measure the flow at Baricho and then "catch" the same water again further down stream. We tried to do this on 3rd September but incurred practical problems with transport for the race across Kenyan countryside, and a quick and proficient metering team. As well as that a dilemma was posed about which section of water we were chasing since it all flowed at different rates. Finally we have tried to compare flows with similar stage measurements allowing for time-lags between the stage measurement at Malindi Water Works and a flow measurement at Baricho Weir.

The results manipulated in this fashion have been represented on Appendices 1 & 2 whereby two different average velocities have been applied for the correction. From those tables we can rather unscientifically select a stock of results on which to base the calculations. However the crude nature of the data makes this not only acceptable but necessary. Hence the representative flows are as follows:

	m^3/s		
BARICHO (1)	19.85,	20.41	
BARICHO (2)	20.09,	18.95	
MALINDI WATER WORKS	16.48,	16.21,	17.89

The average flows are $19.83\text{m}^3/\text{s}$ and $16.86\text{m}^3/\text{s}$ for Baricho and Malindi respectively. The corresponding standard deviations of this flows according to the results are $0.54\text{m}^3/\text{s}$ and $0.74\text{m}^3/\text{s}$. The distance between the two survey points is 56 km. Hence the total loss is $2.97\text{m}^3/\text{s}$ with a standard deviation of $0.915\text{m}^3/\text{s}$, making the overall loss rating $0.0530\text{m}^3/\text{s}$. km. The standard deviations are not really representative of the errors involved since there

should also be some flow variation inherent in the 2cm stage interval that these measurements correspond to.

These results compare with a total loss of $1.16\text{m}^3/\text{s} + 0.28\text{m}^3/\text{s}$ and a loss rating of $0.0187\text{m}^3/\text{s km}$. that are quoted in a Hydrological Survey commissioned by Scott, Wilson, Kirkpatrick and Partners referring to low flows. It should also be considered in relation to the design rates of abstraction at Baricho and Malindi which are intended to be satisfied when the pipeline is complete. These are $0.8\text{m}^3/\text{s}$ and $0.14\text{m}^3/\text{s}$ respectively.

4.4 Loss Curve

The nature of the losses in the channel flow between Baricho and Malindi is a much more tenuous area to judge upon due to the crudity of the data. Appendix 4 plots all the results and obviously fitting a curve to the limited number of points available is not really credible. Only two readings at each of the Jilore and Kakoeni sites and furthermore the suspicion cast on one of each of these pairs of results due to low stage measurements at Malindi Water Works are of limited help.

The question we were attempting to answer was chiefly whether or not an underground stream exists as a tributary to the river from Jilore Lake increasing the flow. Also any other peculiarities of the loss curve between Baricho and Malindi Water Works were of interest, for instance whether the abstraction into the galleries was affecting the readings at Baricho (1) to a different extent than those at Baricho (2) 400 metres upstream.

Even though both the reasonable and comparable flow measurements at Jilore and Kakoeni lie above the average line the suggestion of a possible inflow between these points remained unsubstantiated since a variation in flows like that displayed at Baricho and Malindi could account for this. Similarly the abstractions from the Baricho Weir galleries were of the magnitude of $0.2\text{m}^3/\text{s}$ which is too small to be revealed by the results we have obtained.

4.5 Accuracy of results and conclusions

The general inclination in processing these results and following instincts rather than specific rigorous statistical procedures is justified by the overall accuracy displayed in the results. On the one hand we have assumed an interdependency between the flow measurements and the corresponding stage and yet the flows do not seem to reflect any consistent change. We can for instance apply an approximate correction to each flow where a 1 cm change in stage should increase the flow by $0.375\text{m}^3/\text{s}$ for the average section 70 m wide flowing at 0.535 m/s. This would be rather meaningless for results such as

/those

Fig. 3: Results from current measuring and stage measurements at Malindi Water Works.

SITE & DATE	Time (hrs) { - noon }	STAGE @ (m) M.W.W	ADJ ^d STAGE (m) @ 0.6 m/s	ADJ ^d STAGE (m) @ 1.0 m/s	Flow in river (m ³ /s)
8 AUG '81	-	77.5	-	-	-
9 AUG '81	-	75.3	-	-	-
10 AUG '81	-	72.9	-	-	-
11 AUG '81	-	73.5	-	-	-
BARICHO WEIR (1)	11.08	71.4	72.0	71.1	19.85
BARICHO WEIR (1)	15.50	70.3	72.0	71.6	20.41
JILORE	12.92	72.0	70.8	71.5	19.19
MAUNDI BRIDGE	10.17	70.5	70.1	70.0	14.91
15 AUG '81	-	72.0	-	-	-
16 AUG '81	-	70.0	-	-	-
17 AUG '81	-	72.0	-	-	-
BARICHO WEIR (2)	13.25	73.2	70.0	70.7	20.09
KAKOENI	11.70	70.0	70.0	70.0	19.72
20 AUG '81	-	71.1	-	-	-
21 AUG '81	-	70.8	-	-	-
22 AUG '81	-	71.4	-	-	-
23 AUG '81	-	71.2	-	-	-
BARICHO WEIR (2)	11.63	71.2	72.6	72.6	19.95
KAKOENI	11.75	73.6	65.0	69.2	17.42
JILORE	12.17	65.1	67.2	66.8	16.50
MAUNDI WATER WKS	10.13	67.2	67.2	67.2	10.85
28 AUG '81	-	67.3	-	-	-
29 AUG '81	-	67.6	-	-	-
30 AUG '81	-	70.0	-	-	-
31 AUG '81	-	71.2	-	-	-
MAUNDI WATER WKS	10.58	70.3	70.3	70.3	17.89
MAUNDI WATER WKS	12.52	70.6	70.6	70.6	16.21
MAUNDI BRIDGE	11.42	70.7	70.9	70.8	16.39
BARICHO WEIR (2)	10.63	72.0	?	?	16.72
MAUNDI WATER WKS	15.38	72.0	72.0	72.0	16.48

site	dist (km)	time (hr)	time (hr)
BARICHO WEIR (1)	0.00	+25.33	+15.56
BARICHO WEIR (2)	0.40	+25.74	+15.45
KAKOENI	14.9	+19.01	+11.41
JILORE	25.0	+13.90	+8.34
MAUNDI WATER WKS	56.0	0	0
MAUNDI BRIDGE	60.6	-2.14	-1.28

@ 6 m/s @ 10 m/s

Fig. 4: Distance along Sabaki River

those at Baricho and Malindi where the possible presence of this relationship is refuted by the available data. However it is a useful hypothesis to explain the low values obtained at Kakoeni and Jilore. Applying the correction to these flow measurements (at 0.6 m/s adjusted stages) we get $19.30\text{m}^3/\text{s}$ and $17.85\text{m}^3/\text{s}$ to compare with more reasonable results at Kakoeni and Jilore of $19.72\text{m}^3/\text{s}$ and $19.19\text{m}^3/\text{s}$. But the limited number of such comparisons still do not substantiate that this is the ruling factor governing the changes in the flow. It is probably one factor in many others that can cause such errors.

This further leads to suspicions about the accuracy of our stage measurements, since they were actually not done by us, and also to the subsequent interpolations we imposed on those readings. The readings plotted in Appendix 5 certainly seem rather haphazard. It is precisely such incongruencies that lead us to have only limited confidence in most of our conclusions.

Another interesting facet of the study was caused by the Malindi Bridge flow which was affected by the tides. We were hesitant about current metering under such conditions but on occasions were forced to and had to decide which part of the tidal cycle would give us the most meaningful results. At low tide presumably the river's flow was interfered with the least but we were measuring the average daily flow which would indicate which tide readings were the most appropriate. Due to this confusion the Malindi Bridge results were excluded from any statistical assessment even though one reading correlates well with the others at Malindi Water Works and one is about $1 - 1.5\text{m}^3/\text{s}$ too low.

5.0 Conclusions

It is probably partly the fault of the last minute change from a Weir calibration to a Loss Rating which was forced upon us by circumstances out of our control but the real heart of the project suffered from over ambitious expectations from our crude techniques. We have managed to obtain some undeniably useful general data about the Hydrology of the lower section of the Sabaki River but have not really been about to delve very deeply.

Even so the real nature of the problems the project posed have produced invaluable experiences for those involved.

APPENDIX I : Table to compare Flows measured at similar stage levels.

Stage	Location	BARICHO	KAKCENI	JILORE	MALINDI
73	BARICHO (2)	18.95			
72	MALINDI N.W.	16.72			16.48
	BARICHO (1) JILORE	20.41		19.19	
71	BARICHO (1)	19.85			
	MALINDI BRIDGE				16.39
	BARICHO (2) MALINDI W.W.	20.09			16.21
	MALINDI W.W.				17.89
70	MALINDI BRIDGE + KAKCENI		19.72		14.91
69	KAKCENI		17.42		
68					
67	MALINDI W.W.				16.85
	JILORE			16.50	
66					
65					

STAGE ADJUSTED TO 1 m/s.

APPENDIX 2 : Table to compare flows measured at similar stages.

Stage (cm)	Location	BARICHO	KAKCENI	JILORE	MAUNDI
73	BARICHO (2)	18.95			
72	BARICHO (1) + BARICHO (1) + MALINDI W.W.	19.85 / 20.41			16.48
		16.72			
71	MALINDI BRIDGE				16.39
	JILORE			19.19	16.21
	MAUNDI W.W.				17.89
	MAUNDI W.W.				14.91
70	MAUNDI BRIDGE				
	BARICHO (2) KAKCENI	20.09	19.72		
69					
68					
67	JILORE + MALINDI W.W.			16.50	16.85
66					
65	KAKCENI		17.42		

STAGE ADJUSTED TO 0.6 m/s.

Flow measured (m^3/s)

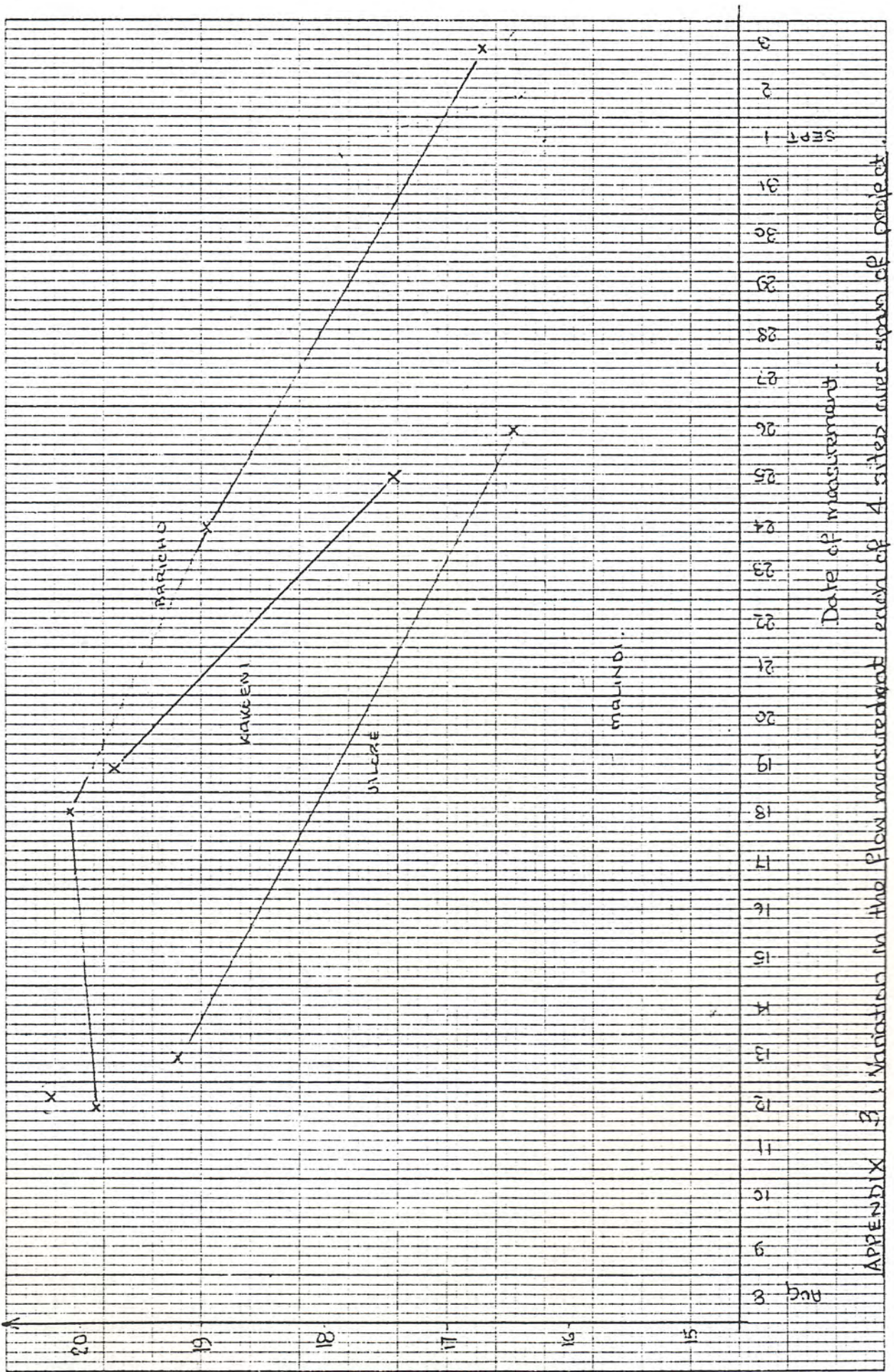

APPENDIX 3. Variation in the flow measured each of 4 sites over span of project.

Flow measured (m^3/s)

APPENDIX 4 : Variation of flows measured along the Sabaki River from Baricho (1) to Malindi Bridge.

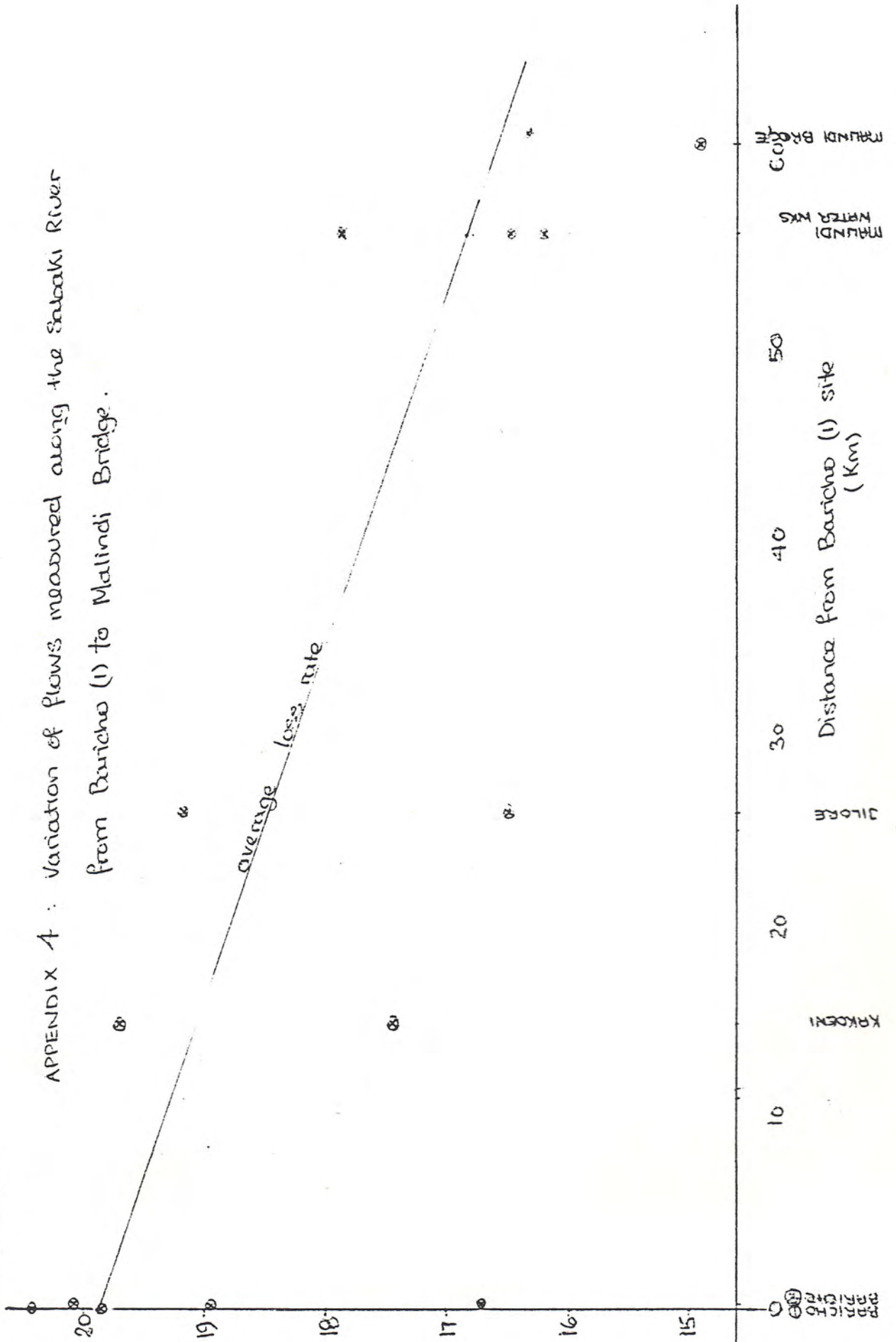

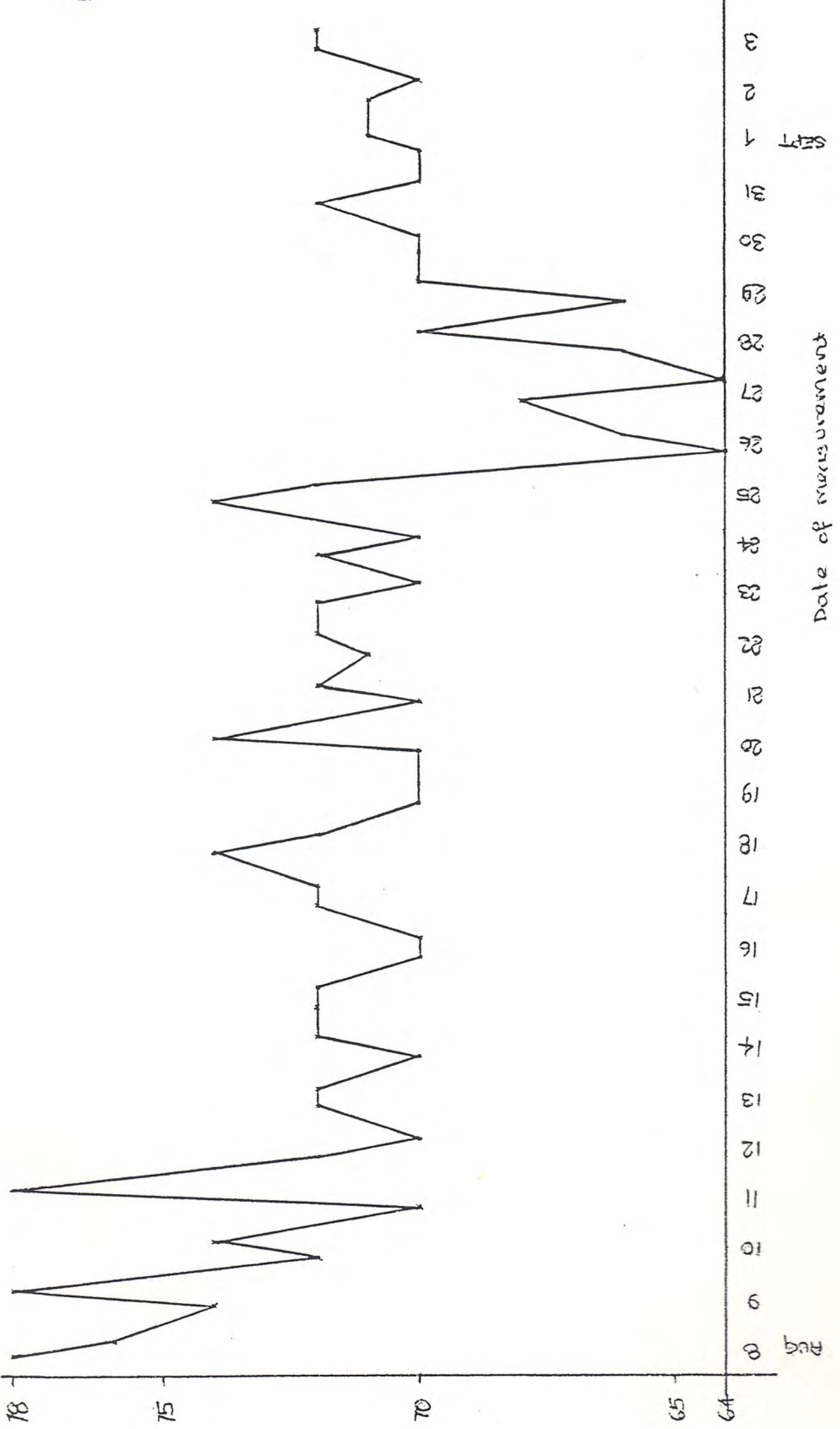

APPENDIX 5 : Change in the stage at Malladi Water Works (measured twice a day)

APPENDIX 6 Diary of Flow measurements

Week 1 Operators: Marek and Glenn

- 10 Aug. - Mr. A. Scott of Scott, Wilson, Kirkpatrick and Partners, has arranged for us to borrow a current meter from Malindi Water Authority for one week. This is a new OH Model, an infinite improvement on the antique brought from Imperial College, with a calibration that can probably be trusted.
- 11 Aug. - The contact to the negative terminal on the meter is loose and is fixed. After a short practice we are all set to go.
- 12 Aug. - An enthusiastic start with two sets of flow measurements. The site Baricho (1) however may be affected by the amount that is being abstracted from the galleries of the Weir. The first measurement has no 6/10d velocity measurements but 4/10d measurements. The second is a shortened version of the full measurement; only at every third knot.
- 13 Aug. - The Jilore site is extremely wide and it is difficult to find a straight section of the river. In the end we ended up by missing two knots so the breadth measurements had to be all equally adjusted.
- 14 Aug. - Sun burn is becoming a problem so "wet t-shirts" are enlisted. Malindi Bridge is a tidal site. When should we take measurements? This is the first occasion that we metered the velocity not perpendicular to the control surface and must adjust this in the results. It is also a site where the river divides into two separate channels.

Week 2 Operators: Marek and Niall

- 18 Aug. - Back at Baricho we are now using a site 400m downstream, Baricho (2) to minimise any effects of abstraction. Unfortunately this profile contained very stony sections about 5m from each bank which made standing difficult.
- 19 Aug. - We have now chosen to measure at both Kakoeni and Jilore sites to try and detect any possible flows from Jilore Lake. Today, at Kakoeni it rains heavily and it is the consideration for the health of some African children intent on helping us, rather than any other selfish consideration or the thought of crocodiles that means we have to adjust the method to

get us out of the water and into warm clothes as quickly as possible. Kakoeni also has many cross-currents due to meanders.

- 20 Aug. - The positive contact this time, breaks and requires soldering. The flow measurement is therefore useless since it is only $\frac{1}{2}$ complete.
- 21 Aug. - An attempt to repair the current meter was inadequate and it means another day is wasted just lying in the sun. Luckily Mr. A. Scott says he can solder the contact for us. Nevertheless we selected a new site near Malindi Water Works.

Week 3 Operators: Niall, Becky and Jenny

- 24 Aug. - A measurement at Baricho Weir (2) marks the start of a relatively trouble free week. I am not present. Just coincidence?
- 25 Aug. - Measurement at Kakoeni
- 26 Aug. - Measurement at Jilore
- 27 Aug. - Finally the first flow measurement at Malindi Water Works

Week 4 Operators: Glenn, Nick and Marek

- 31 Aug. - The measurement at Baricho (2) is terminated when the rain becomes unbearable. Nick and Marek are absent but Jenny and Anne help Glenn.
- 1 Sept. - The Baricho site landrovers which have been kindly ferrying us have problems with their petrol supply. Therefore we are restricted to Malindi locality. One full measurement and one shortened measurement is taken at Malindi Water Works. Glenn is absent.
- 2 Sept. - More transport problems a full measurement at Malindi as much as anything to check the effects of tidal fluctuation in the stage.
- 3 Sept. - Petrol supplies are restored and we manage to complete a whole measurement at Baricho (2) and Malindi Water Works in one day. This is to approach as nearly as possible the 13 hour time lag between water passing at Baricho and that at Malindi Water Works.
- 4 Sept. - The current meter is returned only three weeks overdue but no one seemed to mind. Full stage readings at Malindi Water Works were copied for the period of our measurements. Site visit of Baricho Treatment Works and Weir and the pipeline and Jaribuni bat-caves.

A P P E N D I X 7

References

The Hydrological Survey of the Athi-Tsavo River Catchment -
1973: Scott, Wilson, Kirkpatrick & Partners.

The Design Report for the Mombasa and Coast Pipeline -
1976: Scott, Wilson, Kirkpatrick & Partners

PART 111

THE PUBLIC HEALTH STUDY

Nick Jones
Jenny Egdell

C O N T E N T S

- 1.0 Introduction
 - 1.1. Aims of study
- 2.0 Methods of study
 - 2.1. Village studies - methods
- 3.0 Description of Region
 - 3.1. Geography
 - 3.2. Surface and ground water
 - 3.3. Health of People of the Region
 - 3.4. Vipingo Health Centre
- 4.0 Village Studies
 - 4.1. Bureni
 - 4.1.1 Demographic history
 - 4.1.2 Community structure
 - 4.1.3 Local customs and habits
 - 4.1.4 Education and employment
 - 4.1.5 Horticulture
 - 4.1.6 Animal husbandry
 - 4.1.7 Disease and health
 - 4.1.8 Water supply
 - 4.1.9 Sanitation
 - 4.1.10 Waste Disposal
 - 4.2. Kikambala
 - 4.2.1 Geography and History
 - 4.2.2 Water supply
 - 4.2.3 Water usage
 - 4.2.4 Description of typical well
 - 4.2.5 Problems associated with wells
 - 4.2.6 Possible immediate improvements to wells
 - 4.2.7 Barriers to improvement of present water supplies
 - 4.2.8 Sanitation
 - 4.2.9 Waste disposal
 - 4.3. Vipingo
 - 4.3.1 Introduction
 - 4.3.2 Water supply

/Jaribuni

- 4.4. Jaribuni
 - 4.4.1 Description of the location
 - 4.4.2 Local customs and traditions
 - 4.4.3 Scope of study
 - 4.4.4 Water supply
 - 4.4.5 Sanitation and waste disposal
- 5.0 The New Pipeline - development up to date
 - 5.1. Cost
 - 5.2. Difficulties
 - 5.3. Standpipes
 - 5.4. Conclusion

Appendices

1.0 Introduction

The introduction of a new piped water supply system to a region in a developing country which had previously relied solely on naturally available surface and ground water is a scheme which could bring great benefits and improvements to the lives of the people of that region. The actual engineering phase of the scheme is by no means the final solution however, since its success depends significantly on its impact and level of acceptance in the villages which it supplies.

To compliment the hydrological studies we performed, relating to the new pipeline, we also set out to try and assess the sort of impact the scheme would be likely to make in some of the rural villages it will eventually supply.

1.1 Aims of Study

The public health study was carried out in several rural villages of the coastal region of study, the main objectives being:

- (1) To obtain a general picture of the present problems of water supply, sanitation and waste disposal and also suggest some possible immediate improvements to these problems
- (11) To gain a knowledge of the present health problems of the region, particularly those which were water related
- (111) To attempt to assess the impact of the new water supply and identify some of the barriers in the way of its success

2.0 Methods of Study

It was originally hoped that three villages, each with different water supplies, could be studied in order that a broad picture of existing problems could be obtained.

In fact, when we eventually established our base in the region of study the choice of villages and scope of study was limited to those dictated by our contacts and our level of acceptance by the communities.

In the event three village studies were made, with the help of local school students and villagers and the support of the chiefs of the villages of the region. Also tours of two of the villages alongside the local public health officer from the regional health centre proved very informative.

2.1 Village Studies - Methods

A rough map of each village was constructed showing the village centre, with any shops and important community buildings, and the position of the family compounds of the periphery.

The most important features marked on the maps were: the location of water wells and other water appliances; and the position of certain pit latrines, waste pits and drainage facilities.

A description of the water supply and waste facilities was made, noting any obvious associated health problems and constructional defects.

Finally, a variety of co-operative households were interviewed to obtain such information as:-

- (1) size of family group
- (2) distance to nearest water supply
- (3) average time spent fetching water and quantity per day
- (4) sanitation and waste disposal facilities
- (5) general health of household

On the whole the villagers were extremely helpful and after brief suspicion and hesitation, were quite willing to answer any questions we posed. We were often treated with great hospitality and invited in for drinks of chai (local tea) or mnazi (an alcoholic drink made from coconut palms and drunk through a reed-straw).

Visits to the villages were made by groups of two or three of the party as the small number allowed for efficient gathering of information and was also less imposing on the village communities.

The translating of our questions, into and from Swahili, was done by our village contacts, and our thanks are once more extended to our friends in the locality for their invaluable help and good company.

3.0 Description of Region

3.1 Geography

The villages studied lie in the region between Kilifi and Mombasa and were typical of this 50 km section of the Kenyan coastal region. The region is formed politically of three sub-regions of roughly equal size, these being:-

- (1) Mauveni, in the North
- (11) Junju, in the Centre
- and (111) Mtwapa, in the South

Whilst some of the villages close to Mombasa are fairly well developed, our studies were concerned with less developed rural villages.

The region lies in an area of equatorial grasslands and experiences a monsoon climate. The seasonal rains are fairly reliable (although they have failed on two occasions in the last ten years) and the land is fertile for much of the year supporting crops as varied as: coconuts; cashew nuts; cassava; maize; tomatoes and aubergines.

Most of the villagers survive by subsistence farming and there is a certain amount of large scale crop farming (previously owned by colonial farmers, though being taken over more and more by the State). The region houses one of the largest sisal estates in East Africa and a cashew nut factory in Kilifi.

3.2 Surface and Ground Water

Very little surface water is present due to the hot climate and seasonal rainfall. During the rain periods occasional flooding of low lying areas does occur but streams which form during this period generally dry up very quickly.

Most water is present in the form of ground water, found at a depth of 15 - 20m.

The quality of water present depends on the type and position of the source, but is generally brackish at sources less than 3 km from the sea.

3.3 Health of People of the Region

The general health of the rural population is poor, most people suffering from water-related and other diseases. Much was learned concerning the common diseases from talking to the villagers and also the officer and staff of the local area health centre at Vipingo. There is however, much conflicting opinion on the nature of the diseases, with the health officers having to fight an uphill battle against local superstitions which are still rife and hold up the progress of modern medicine in the area.

A large proportion of the people suffer from malaria and diarrhoea and vomiting, whilst there is also the occasional outbreak of Typhoid and Cholera. Bilharzia is found (although not in the villages we visited) and measles affects most children at some stage. The symptoms of malnutrition were seen in the cases of several young children, whose diet was significantly lacking in protein.

There was an outbreak of typhoid in the Junju location which had effect from 21.4.81 to 31.5.81, the symptoms of which were continual diarrhoea and vomiting. To illustrate the scale of the outbreak the following statistics show the number of recorded cases during that period in some of the villages of the region.

/Table 1

T A B L E 1

Classification of Water-Related Infections
Typical of those found in the Coastal Region of Study

	<u>Category</u>		<u>Examples</u>	<u>Relevant Water Improvements</u>
1	<u>Water-Borne</u> Infections spread through water supplies	(a) Classical (b) Non Classical	Typhoid, Cholera Infective Hepatitis	Microbiological Sterility Microbiological Improvement
2	<u>Water Washed</u> Diseases due to lack of water for personal hygiene	(a) Skin & Eyes (b) Diarrhoeal	Scabies, trachoma Bacillary Dysentery	Greater volume of available water
3	<u>Water Based</u> Infections transmitted through aquatic invertebrate animal	(a) Skin Penetrating (b) Ingested	Schistosomiasis Guinea Worm	Protection of User Protection of Source
4	<u>Water-Related Insect Vectors</u> Spread by insects dependent on water	(a) Biting near Water (b) Breeding in Water	Malaria, Sleeping - Sickness Yellow fever	Water Piped from source Water piped to site of use
5	Infections of Defective Sanitation	Diseases i.e. Hookworm	Hookworm	Sanitary Faecal Disposal

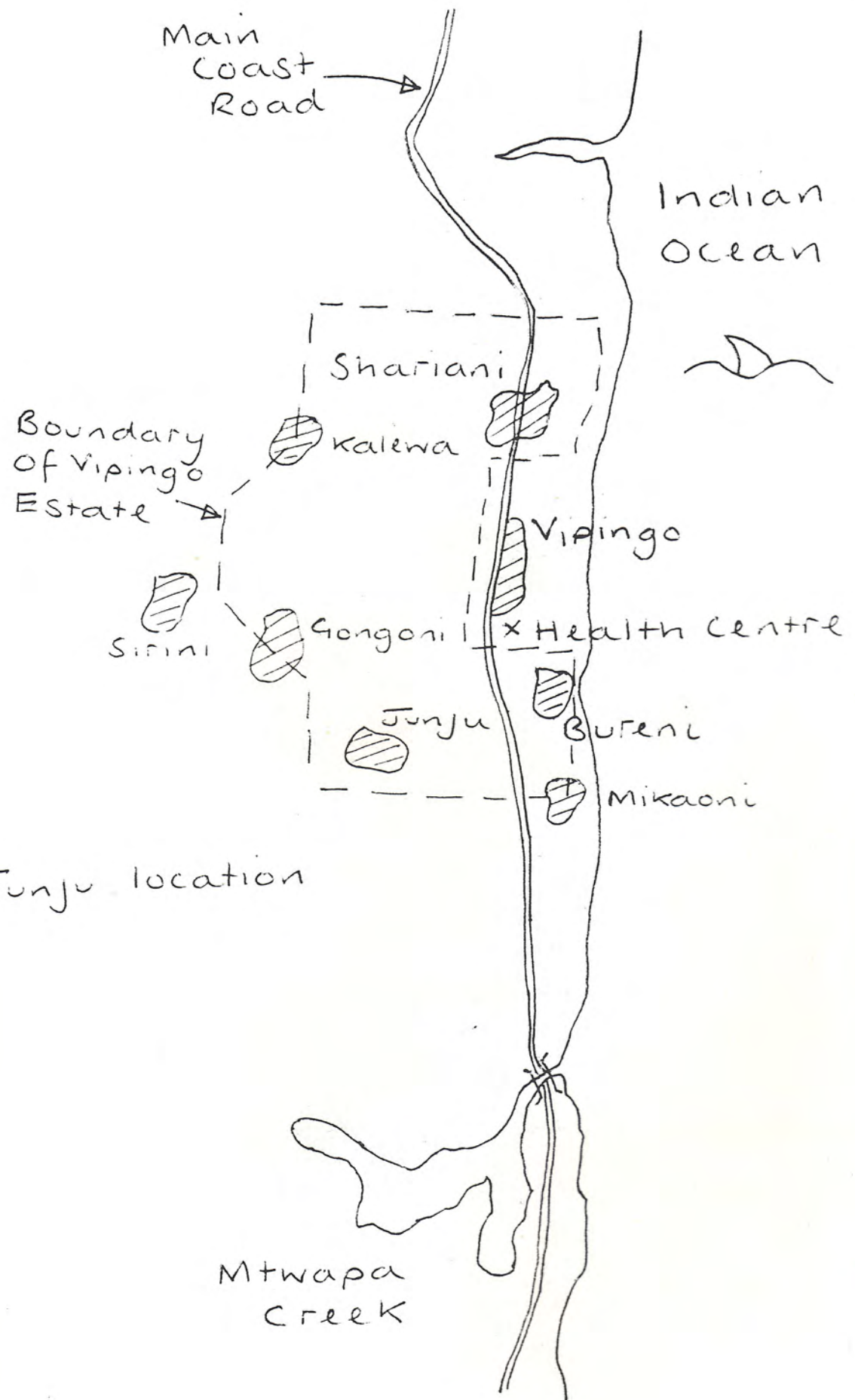

Fig. 1. Junju location

Table 2 - Outbreak of Typhoid in Junju Location (April/May 1981)

Village	Population	No. of Recorded Cases
Mikaoni		2
Gongoni	2,700	12
Kalewa		1
Sirini		1
Bureni	300	11
Vipingo	3,300	4
Junju		4
Shaniani		2
<u>TOTAL</u>		<u>37</u>

Fig. 1 Shows a map of the Junju Location, with the affected villages marked, and the position of Vipingo Health Centre.

3.4 Vipingo Health Centre

A warm and friendly relationship was formed with the health education officer (Mr. Ernest Mwandasa) and some public health students from the Vipingo Health Centre. It is their jobs to inspect the health standards of the shops and cafes in the villages and also to instruct the villagers on the upkeep of wells, sanitation facilities and domestic cleanliness and hygiene.

They were based at the Vipingo Health Centre where specialized clinics dealing with health education, family planning and diseases are held.

Whilst there is a fair size hospital in the town of Kilifi the only reasonable health facility within the Mtwapa, Junju and Mauveni locations is the Vipingo Health Centre situated on the outskirts of the village of Vipingo. The Centre is quite accessible, being on the main Mombasa - Kilifi Road, but some villagers from more remote locations find it difficult to reach and so a mobile clinic operates out of Vipingo and visits these locations once a week (that is when it isn't broken down).

The Centre is small and has a simple, practical layout possessing a treatment room, dispensary, a small maternity ward and a post-natal clinic. A recent development at the centre has been the introduction of a family planning centre.

The local response to the Maternity Section is encouraging since the number of births there each month is steadily increasing. The response to

the family planning clinic is less enthusiastic due to more complex traditional and religious opposition.

The Centre treats with a fair degree of success, over one hundred patients a week, suffering from cuts and bruises to T.B. and Malaria. It also holds a leprosy clinic once weekly.

A new and hygienic well, on the health centre compound, supplies the Centre with plentiful, clean water. A sanitation and drainage system, connected to a well-maintained septic tank, adequately caters for the Centre's needs.

4.0 Village Studies

4.1.0 Bureni

As a first step in obtaining an insight into the traditions, customs and community structure of a village typical of the region, a simple survey was conducted in the small village of Bureni.

The survey was performed with the generous help of some school students whose families lived in Bureni and gave us a general picture of the water supply sanitation and health problems present and invaluable experience in diplomacy and local etiquette.

The culture, customs and community structure existing in Bureni are typical of all the villages of the region, although the community structure of larger villages is slightly more advanced.

During the two week study we were first introduced to the sub-chief who welcomed us and introduced us to his family. His daughter (training to be a primary school teacher was very helpful in showing us the life of a woman in the village as most of the women we met spoke no English.

We then met a group of elders and joined them in drinking Mnazi (much to their amusement). The rest of the study involved mapping the village and meeting and talking (with our translators) to the villagers.

4.1.1 Demographic History

Bureni has a population of about 300 people and is situated about 200 metres from the main coastal road that runs from Mombasa to Malindi. It is about 2 km from the small town of Vipingo.

The first houses of Bureni were built in the late 1930's. Three brothers travelled about 20 km down the coast from Dindiri with their young families. These brothers are now the elders of the village and their families compose the present population.

The name Bureni is derived from the Kiswahili word "bure" which means free of charge:- this was due to the fertility of the land making cultivation easy.

/During

During the 1940's this whole area was bought by the sisal estate owners and so the villagers officially became squatters, although within their own social hierarchy they still consider the elders of the village as the owners. The government has tried to nationalise the estate which would essentially give the land back to the people - but the price was too high. They have also offered the villagers alternative land but the terrain was more difficult and they refused to move.

4.1.2 Community Structure

There are eight family compounds within the village, interspersed with palm trees and cultivated land. The area is within the flat coastal plain and Bureni itself is 3 km from the coast.

Within one family compound there are a number of different buildings. Most of the houses are made from mud and sticks with palm leaf roofs - called makuti. There are however still a few of the older style houses which are entirely covered with palm leaves - majanni. Smaller houses made from only sticks and palm leaves are used for cooking and cleaning purposes. These buildings are grouped in small family areas within the compound.

Outside these groups is usually a boma which is constructed from palm leaves and has no roof, and usually old coconut shells on the floor. This acts as a latrine and bathroom.

Ideally there should also be one pit latrine per compound. In Bureni, in the whole village, there was only one and that was still under construction.

The distribution of the family within the compound is decided by the eldest man, or elder. The usual arrangement is one house for a man and his wife or wives. Depending on his wealth the children may have a separate room. When the sons reach about 14 they are old enough to live by themselves and will build their own houses, perhaps taking a sister with them to cook and clean. When a girl gets married she moves to her husband's village.

All houses are single story usually with only one room which may be sub-divided by palm leaf walls.

The furniture in a house normally consists of a bed with a wooden frame and palm leaf lattice, one or two seats and cooking utensils.

4.1.3 Local Customs and Habits

The Bureni people belong to the tribe of Chonyi and the main language spoken is Kichonyi. This is similar in construction to Kiswahili but has not been influenced by Arabic to the same extent.

The religion of the Bureni people is principally Christian, with Catholic,

/Pentecostal

Pentecostal and Methodist tendencies. There are also (in Jeffrey's own words) "a few pagans", and in Bureni itself there is one Muslim.

Superstition is very strong among the people, but with increasing education and westernization of the younger generations the importance of the old customs and traditions is decreasing. However among the older members of the village the old style "magic" still comes before western medical practice.

The most important official in the area is the chief, who represents the local government. Most villages have their own sub-chief who assists the chief in his duties. However the social hierarchy of the village is basically determined by the age and sex of each member. The most respected member is the eldest man followed by all other males in decreasing age, then the eldest woman down to the youngest girl who is at the bottom of the social system.

The utter subordination of the women is exemplified by the practise of paying a "bride price". When a girl is married her father takes the money, and then can afford the marriage of one of his sons. If he has no sons of marriageable age he will take another wife for himself.

The men are expected to earn and the women to cook, clean, carry water and work on the shamba. The young boys help work on the shamba and the young girls help to collect water and look after the smaller children.

4.1.4 Education and Employment

Primary school education - standards 1 to 6 - is free for all children. Most children attend fairly regularly. They start school at 6 years of age and leave at 12 or 13 depending on how old they start and whether they repeat years.

Secondary school education must be paid for and the price varies depending on the school. There are state schools, missionary schools and harambee schools. If the father can afford it he will send his eldest son to school, younger sons get second preference and last of all the girls. In many cases the idea of sending a girl to secondary school is not even considered, they assume that the girls are not interested. However an education will increase the bride price of a daughter. An older brother is expected to contribute to the price of his younger brothers and sisters education.

All the villagers spend time working their shambas which provide fruit and vegetables. However the increasing availability of western goods and the unreliable rainfall leads most of the men to Mombasa (20 km distance) or Kilifi (30 km distance) in search of work. Some find employment on the sisal estate but, in general, work there is very badly paid.

/The

The women of the village are not expected to find work, merely get married and produce children. However, some find work as house-girls and with increasing education some are training to be primary school teachers. Apart from these opportunities, they too must move into the towns to find work.

4.1.5 Horticulture

The elders of the village designate plots to each family compound. The elder of the compound then shares the land between the houses. Each family will then clear the land and grow crops of their own choice.

The crops grown in Bureni include maize, coconut palms, cassava, peas, pumpkins, bananas, pawpaws, tomatoes, sukumi wiki, cashew nuts, ground nuts, aubergines, potatoes and beans.

The rotational system of agriculture is used within the plot to help retain some of the soil nutrients. No form of fertilisation is used. Irrigation is not necessary due to the seasonal rainfall in the area, and the coconut palms act as a cover during heavy rain, preventing leaching of the soil. Insecticide is too expensive to be considered and so virtually the only form of attention the plants receive, after sowing, is some irregular weeding.

Farming is basically at subsistence level and most of the produce goes for the family's own consumption. However some tomatoes, potatoes and aubergines are sold when in plentiful supply.

The palm trees provide a variety of forms of food - the young coconuts are eaten fresh and the milk is drunk, the older coconuts are used in cooking. Also the local alcohol "mnazi" is produced by tapping the overripe coconuts after allowing the juices to ferment while still on the tree.

The pea and pumpkin plants are used for human consumption in their entirety - fruit and leaves.

4.1.6 Animal Husbandry

Chickens and ducks are allowed to roam freely around the shambas. Goats are tethered near to the houses then taken to pasture during the day on any suitable grassland nearby. They obviously cannot be allowed to eat the vegetables. In Bureni the grassland among the sisal, although rough, was ideal fodder for the goats. Cats and dogs are also encouraged - by feeding - to stay around the shamba to keep down rodents, snakes and thieves.

With the chickens free roaming there are obvious problems with the collection of eggs, but it is only recently that they have begun to eat the

eggs at all. It has always been a local tradition not to eat eggs and it is only with education that they are coming to realise their nutritional value. Basically the chickens and ducks are kept for meat, one is slaughtered on a special occasion in the family, similarly with the goats (although they may be sold) except that some milk is also obtained from them; the slaughtering of the animals usually takes place adjacent to the cooking and eating areas - providing an obvious source of infection and health risk.

Another health risk arises from the waste of the animals which is indiscriminately ignored, unless lying directly on a path when it may be kicked out of the way. No use of it is made of as compost for the shamba.

Waste from the animals tied up near the houses attracts flies to the cooking and cleaning areas of the compound.

4.1.7 Disease and Health

Health care is available locally at the Vipingo Health Centre. Patients can receive treatment for malaria, and typhoid when an epidemic is apparent. The health centre is obviously a great attribute to society but there still remains some problems associated with "modern" medicine. There is still competition with traditional healing methods.

Care must also be taken not to offend the pride of the people. For example, during the recent typhoid epidemic (see section 3.3) treatment was offered to the whole area. The treatment involved an anal swab and the men of the village found it embarrassing to stand in the same queue as their mothers and sisters.

By improving the sanitation facilities the number of diseases common to the villagers could be reduced. However some problems still remain, for instance, people using the local wells are instructed to boil the water. This method of protection is totally impractical due to the temperature of the environment which makes rapid cooling impossible. There are also difficulties in teaching people the advantages of what seems to them wasted time and fuel.

Another problem in Bureni is leakage from the storage tank and tap. This leads to flooding since the area around the well is poorly drained, making water collection unpleasant and creating a possible health risk.

4.1.8 Water Supply

The source of water in Bureni is a well situated to the west of the village, built by the sisal estate owners. It is about 20 m in depth and the water is drawn up by means of a windpump, and then transferred to a storage tank,

/from

from which it is collected, via a tap, by the villagers.

This well serves the entire population of Bureni. Thus villagers living at the eastern extremity of the village must walk about 1.5 km to fetch water. The villagers do not have to pay for the water. If this supply dries up during a lowering of the water table in a long dry season, or if the pump breaks down, then the villagers must go and buy water from Vipingo - 2 km away, or go to another well built by the sisal estate - 5 km away.

The water collected is used for cooking, drinking, personal washing and washing of clothes and utensils. If possible the women save carrying extra water by taking their clothes to the tap to wash. An average family (3 adults, 7 children) requires about 40 litres of water a day, which means at least 5 trips to the water source every day. An obvious disadvantage is the enormous amount of energy that must be used by the women in fetching water.

The wind pump saves manual extraction. The well is covered and thus relatively hygienic since it prevents contamination by users and prevents entry of dust and dirt. However leakage is often a problem, (see section 4.1.7).

4.1.9 Sanitation

The main form of sanitation in Bureni is the boma. The villagers urinate in particularly insanitary and unhygienic bomas, of which there are usually one or two per compound.

These structures are open, poorly constructed and lack any form of proper drainage. Not only do these structures transmit disease to their users but, under rainy conditions, often flood resulting in large areas of the surrounding ground being contaminated by "pools" of waste and possibly also contaminating nearby water supplies.

Defecation in the bush is the common practise due to the lack of any other facilities such as pit latrines.

Problems associated with the unsatisfactory sanitary conditions include: Health risks from the bomas (as previously mentioned); and from children playing in infected pools; paper and leaves used for anal cleaning are left in the bush or around the houses, hence attracting flies.

4.1.10 Waste Disposal

In Bureni the solid waste includes excretory matter, vegetable matter, and small quantities of paper and plastics, which - due to their life-style - the villagers have little use for. Also empty tin cans from further waste.

All the waste produced is not automatically discarded, for instance the old tin cans are used as cooking and drinking utensils. Vegetable waste is small due to the large proportions of the plant used as food, any remaining



P.1. Typical Well

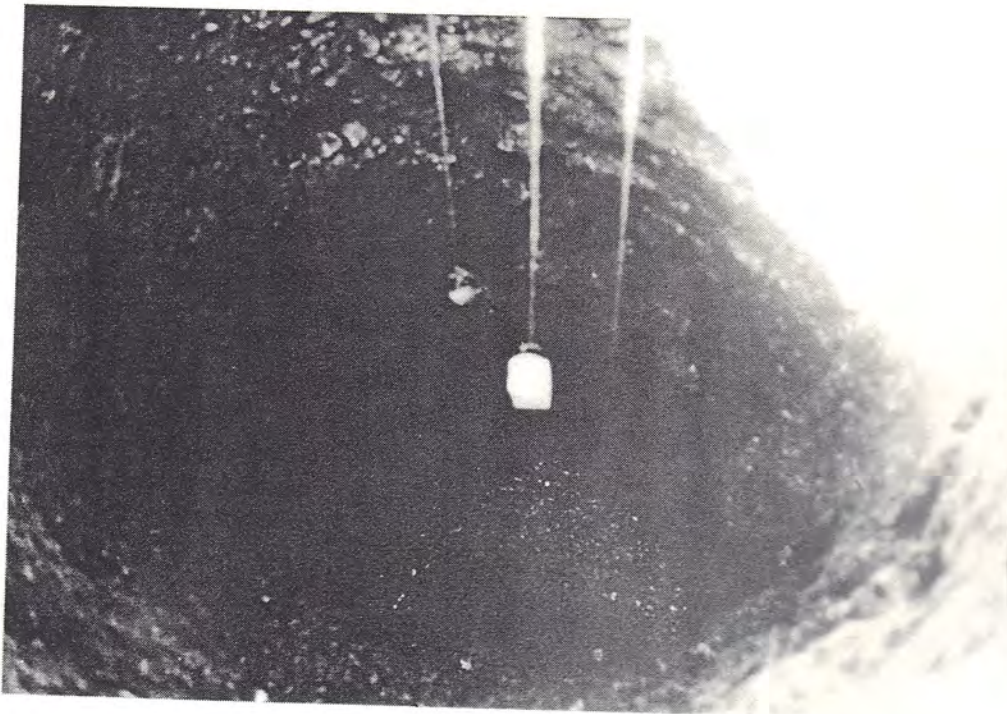

P.2. View down well.



P.3. Bad drainage around well

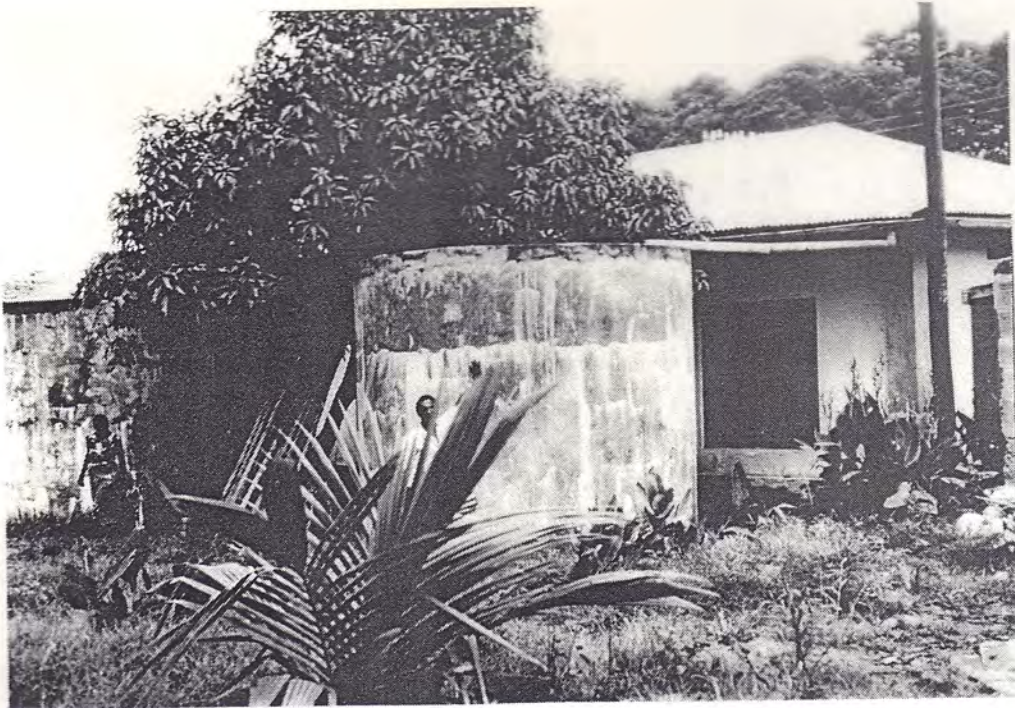

P.4. Water tank for collecting rain water.



P.5. Wind pump on
Vipingo estate.

P.6. Typical stand
pipe.





P.7. Boma (urinal)



P.8. Latrine (open pit type)
under construction.

provides fuel for cooking. Paper and cardboard is used for cleaning until it disintegrates.

Any waste that does remain is simply thrown into the bush, or occasionally, if a large amount of waste is accumulating, a pit is dug and the refuse is burnt.

Problems arising from the disposal methods used are the attraction of flies to decaying matter around the houses, the smell and rodents. Also the tins used for drinking soon rust due to the brackish nature of the water, and any cuts result in infection.

Waste water from cooking and cleaning (or sullage) is discarded directly outside the house and thus infections spread rapidly particularly if flooding occurs.

4.2. Kikambala

4.2.1 Geography and History

The village of Kikambala is situated close to the main Mombasa-Kilifi Road about 20 km North of Mombasa.

It has a population in the region of 1,500 centred largely around the village centre and in three or four smaller village groups on the periphery of the main village and extending into the uncultivated bush-land towards the sea.

In the village centre are several small shops, including a "chai" shop (or local cafe selling tea), and also a small Muslim Mosque, built as a gift by one of the Arab Countries. This serves as a school for Muslim children as well as a place of worship.

The village has developed on a convenient stopping place for travellers from Mombasa and the men in the village find employment on the sisal estates, as farm labourers (there is a large chicken farm nearby), as fishermen or as small traders and merchants.

The community structure has developed on the same lines as Bureni and the local customs and traditions are similar, although the Village is predominantly Muslim.

Connections with the villagers were initiated following a public health visit accompanying the team from Vipingo Health Centre. Freedom of the village was permitted by the village elder and the study carried out with the help of local students and acquaintances.

4.2.2 Water Supply

The village of Kikambala has no present piped water supply, its

/inhabitants

inhabitants rely solely on water extracted manually from open hand-dug wells. There are three wells in or near the village centre of which only two are constantly in use by the villagers: the third being a well-constructed, deep well complete with diesel pump situated in the grounds of the mosque, which, unfortunately, serves only the mosque. There is a further well on the periphery of the village, about 1.5 km from the centre, which serves some of the peripheral households.

The two wells in the village centre are $\frac{1}{2}$ km apart and each one supplies up to 400 inhabitants, which is twice the normally acceptable capacity for such a well.

4.2.3 Water usage

A typical family grouping is made up of 6 people (2 adults and 4 children) and their average daily water consumption is 25 litres. The water is fetched by the women and children in 5 litre tins called "debes". Several journeys have to be made each day of distances of between $\frac{1}{2}$ - 1 km, for families living in the centre of the village, and between 1 - 2 km for families on the edge of the village. A housewife spends about 2 hours per day collecting water, which involves not only the walking over long distances but also the physical abstraction by rope and bucket at the wells. A feature of the wells in the village centre is that during the dry season the well water level becomes exceedingly low. During this period they become clogged with dust and silt making water abstraction impossible. The consequence of dirt is that families have to spend many hours queuing to use congested wells or walk much longer distances (often up to 4 km) to obtain water from another source.

The people in the village use only the bare minimum of water for survival. Water is rationed for drinking and cooking purposes only and very little is left for maintaining personal and household hygiene.

4.2.4 Description of Typical Well

A typical well is 15 - 20m deep and 1.5 - 2m in diameter. The walls of the well in the clay/surface soil layer are lined with local stone: this is provided for support and to prevent contaminated ground water near the ground surface percolating into the well. A wall of stone and cement of height 1m protects the mouth of the well and a poorly constructed apron of the same material surrounds the mouth of the well: the apron extends about 1m from the well but is well worn and eroded and stands at the same level as the surrounding ground surface.

The well is open and two stone pillars 1.5m high act as supports for a cylindrical metal bar across the centre of the well.

Water is abstracted manually by means of ropes and buckets - the bar across the well acting as a form of frictionless pulley, over which the ropes are passed.

4.2.5 Problems Associated with Wells

- (1) Slope of ground surface influences the flow of surface water and other material near the well. Adverse surface-slopes cause contaminated material to flow towards the well, causing (a) contamination of well water by percolation into well, and (b) pollution of the surface locality around the mouth of the well.

A good example of this problem is the well supplying the periphery of Kikambala.

This well is sited at the base of a small, bush-covered hill. The villagers and their livestock use the bushes to defecate in and consequently pollute the hill slopes. In rainy conditions the polluted surface water flows down the hill, polluting the well water and environment.

- (2) Close Proximity to Sanitation and Waste Pits. One of the Kikambala wells was situated 10 m away from an old refuse tip. This results in contamination of the well water for the same reasons as (1)
- (3) Open Wells. Due to the open nature of the wells the entry of dirt dust or insects such as flies cannot be avoided. The stagnant water in some wells makes ideal breeding grounds for mosquitos and aids the spread of malaria.
- (4) The walls around the mouth of the well are poorly constructed and often in a state of disrepair. This poses a danger of flooding and a danger risk to young children.
- (5) Aprons. These are poorly constructed and do not allow adequate drainage away from well mouth.
- (6) Impermeable linings. These tend to be of poor quality and in some cases the mortar has been worn away allowing seepage of contaminated surface water into the wells.
- (7) Ropes and Buckets. Bacteria carried on these, are passed into the well contaminating the water.

4.2.6 Possible immediate Improvements to Wells

- (1) Improve location
- (2) An area 15m radius from well should be cleared to allow proper drainage of water around well.
- (3) Improve Apron quality of construction. Also raise apron 15cm above

/surrounding

surrounding ground surface and construct a soakaway.

- (4) Improve quality of well lining - by possibly importing cement grout.
- (5) Disinfection. The use of chlorine tablets or a chlorination pot would improve water quality by removing pathogens from the water.

4.2.7 Barriers to improvement of present water supplies

- (1) Lack of finance for well-improvement schemes which involve the import of new materials to the villages.
- (2) Problem in motivating villagers due to present lack of appreciation of benefits of cleaner water supply in terms of health.

4.2.8 Sanitation

Each household has one or two "bomas" for urinating purposes but only about one in five have access to any latrine. The latrines in use are simple pit latrines, or "long drops", being little more than holes in the ground about $\frac{3}{4}$ m square and between 6 - 8 m deep, covered by a wood and earth lattice, leaving a hole over which to squat. They are surrounded by a housing of wood lattice. Some of the richer families have pit latrines with concrete floor and housing with a fly proof gauze as ventilation: these are much more hygienic models and are easier to maintain and keep clean.

The pits last a family about 5 years and when they start to fill up, the villagers add paraffin and salt to increase the rate of decomposition.

The construction of these pits is the responsibility of the men. Usually a "harambee" effort is needed to build them because of the physical difficulties involved.

The cleaning of the latrines is the responsibility of the women of the household, who generally wash the latrines once every day or two days.

The pit latrines are often unclean, attract flies and are quite unhygienic. However, they are an improvement to the habit of indiscriminate defecation in the bush.

Following a recent cholera epidemic in the region a programme is being implemented by the local health officers to ensure the building of one pit latrine per family grouping.

The programme's success so far has been limited by the indifferent response of the villagers.

Also, there exists the problem that villagers prefer to defecate in the bush even when having access to a pit latrine. There is evidence of this in that several latrines built in the last few months have hardly been used.

4.2.9 Waste Disposal

Most household waste is disposed of by discarding into the nearby bushes or burning in waste-pits, similar to Bureni. Whilst most waste water from washing and cooking is simply thrown into the courtyard, where it poses an immediate health risk, some larger households had constructed drainage channels to transport waste water from their courtyards to a nearby area of natural drainage.

One particularly unpleasant waste channel was observed in the village centre itself. Here, an open concrete lined channel carried waste water and rotting material from several shops and transported it to an area of marshy ground some 50 m away, close to several large family compounds. The open channel contained pools of stagnant water, which attracted flies, whilst much organic waste lay open and rotting on the marshy waste ground. Chickens and goats feeding on this waste transport bacteria to the households, spreading disease.

4.30 Vipingo

4.3.1 Vipingo is a fairly large village situated about 28 km north of Mombasa, again on the Mombasa-Kilifi Road. With a population of 3,500 it is one of the largest villages in the Junju location. As well as housing the area health centre it also has a mosque, a small Christian church and a "thriving shopping centre".

The village population is spread out over a wide area; in several smaller village groups and in the village centre itself.

The structure of the village is very similar to that of Kikambala and thus a comprehensive survey was not carried out in Vipingo. However, it has a more advanced water supply system which was worthy of study.

4.3.2 Water Supply

Whilst the majority of the villagers rely on the many open, manual wells present, the villagers living in the village centre obtain water from a pumped well source.

The water is pumped, from a covered well about 20 m deep, by a small diesel pump operated from a small wooden kiosk constructed at the top of the well. This water is then pumped into a concrete storage tank to await distribution.

The villagers purchase their water, from the owner of the kiosk, at a price of about 1 pence per debe (5 litre container).

Several of the richer shops have water piped to their own storage tanks

/situated

situated at roof level.

The water is cleaner from this source as the well is covered. Many villagers, thus, prefer to obtain their water from the Kiosk for the above reason and also as it saves energy in physical abstraction.

However, a lot of the villagers still must use the open, manual wells since they provide a source of free water. Also, many housewives are not prepared to walk long distances to the Kiosk if there is an open well closer to hand.

4.4.0 Jaribuni Village

4.4.1 Description of the location

The main difference between Jaribuni and the other study villages is its inaccessibility. It is situated inland at the tip of Kilifi Creek, fifteen miles off the coastal tarmac road. It is served by one very unreliable bus and so the journey to it often includes a six mile walk.

It is a relatively large and dispersed village (about 1,000 people within a two mile radius of its centre) which contains the chief's camp for Kauma location. It has recently become a more important place with the building of a re-pumping station for the new Mombasa Water Supply project on its outskirts.

The village is dominated by Hemed and Salim Said, two Arabs who own a shop there. They also run a farming business and effectively run the two village schools.

4.4.2 Local customs and traditions

The local tribe are the Kauma, as opposed to the Giriama and Chonyi of the other study-villages. This provides no significant difference in customs or traditions as the three tribes are all sub-groups of the Mijikenda, the nine related coastal tribes. The main difference between them is size and consequently power, the Giriama being much larger.

In general, the Kauma are less sophisticated than the Giriama, the "old ways" still having quite an influence on most people in the village. For example, there are four practising witch-doctors.

4.4.3 Scope of Study

One of the members of the team, Glenn Harris, had previously spent a year living in Jaribuni, working as a volunteer teacher at the secondary school. This made access to the village and introductions to local people easy.

Most information was collected by observation and interview. However,

one very interesting afternoon was spent discussing the problem of water supply with some of those most directly affected by it, the women of the village. At the primary school, after lessons have finished, there is an adult literacy class every afternoon, attended by mainly women. One afternoon we sat in on a lesson and were able to hold a discussion (with the aid of an interpreter) afterwards. This was a unique opportunity to obtain the opinion of wives, who would normally probably not be allowed to speak in front of their husbands and would be too shy to speak on their own.

4.4.4 Water Supply

The villagers of Jaribuni are relatively fortunate that they have a choice of three different water supplies; a river, hand-dug wells and stand-pipes.

The river runs to the north of the village, about 500m from the centre at it's nearest point. It is of reasonable quality, the main problem being the sediment load rather than the presence of pathogens. There are no other large settlements upstream of Jaribuni on the river, to pollute it. The size of the river is very variable, varying from 30m wide and 1m deep in the rainy season, to 3m wide and 30cm deep in the dry season. However, it is always possible to draw water from the river except in very exceptional conditions.

Hand dug wells in the area are in general quite shallow (2 - 3m deep) and situated in a valley. The area is quite hilly and so the water table tends to be quite high in places.

The quality of water in these wells tends to be very poor, because of their situation. Their depth also makes abstraction quite difficult, as the depth of water is often not sufficient to accommodate a bucket, and so a tin can on a stick has to be used.

Piped water was brought to the village by the Arab shopkeepers who have installed a tap in the courtyard of their own house, a standpipe in the middle of the village, from which they sell water, and standpipes at the two schools. There is also one other standpipe, which is owned by an African family who live near the centre of the village. At the time of our visit the supply had been disconnected because of non-payment of bills.

It seems that there are three main factors influencing the choice of source. (1) The distance between the source and the home, and the nature of the journey (hilly, through bush, etc.) (2) what the water will be used for. (3) the cost of the water.

Women may spend quite a large proportion of their day fetching water

/and

and can often be seen carrying very heavy buckets on their head for quite long distances. A large container may contain 20 kg of water and may have to be carried up to a mile.

River water is usually used for personal hygiene (many people actually bathe in it) and washing everyday clothes, but it is not preferred for cooking or washing special clothes, because of the sediment load. It would be used for drinking without boiling. Well water is used in a similar way to river water and again is not used for cooking, if tap water is available, as it is said to affect the taste of the food.

Of course, tap water would usually be preferred in any instance but sometimes cannot be afforded. The shop gives a certain amount of credit to the people who buy water there, and at about only one penny a gallon it is surprising that some people sometimes have to go without clean tap water, but they do.

It is also interesting to note that the one African family in the village who could afford to pay for the installation of a tap, could not afford to pay for the water they used. African incomes tend to be very erratic and so the payment of a lump sum is not always as much bother as the payment of regular bills.

The people of Jaribuni would seem to be very lucky in that they have access to a clean, piped supply and also have a choice of sources, which ensures that they will always have water.

The women of Jaribuni, in general, have to work very hard to look after their husbands and families. Going to collect water is one of the only times they are able to socialise with women from different parts of the village. Thus, if the piped water supply network was enlarged within the village to have more outlets, it may be found that the majority of women would only use one outlet to preserve this socialising.

4.4.5 Sanitation and waste disposal

The problems and local habits concerning sanitation are not significantly different in Jaribuni to those studied elsewhere. People are being encouraged to build open pit latrines, and local government officers are supposed to report families who do not. This method of improving public health does not seem to be progressing very fast, and even the threat of imprisonment does not seem to spur people into action. A better system would be to employ people to visit villages and dig latrines. Neither the equipment nor manpower required would be very expensive, and savings would be made in reducing the pressure on local hospitals to treat illnesses caused by poor sanitation. Waste is also disposed of in the usual way. Useful objects,

like tin cans, are not thrown away, and other refuse is just dumped in pits and occasionally burnt.

4.4.6 The effect of the New Mombasa Water Supply on Jaribuni

At present Jaribuni is connected to the Mzima Springs supply but will eventually be linked to the new supply. The changeover should not drastically alter the water supply to the village.

However, the new supply has had quite a large effect on the village in another way. The pipeline actually passes just to the north of Jaribuni, and it's construction has meant a vast increase in the traffic on the Jaribuni road. This has meant better communications with Mombasa and an increase in prosperity for the Arab shopkeepers, which will in turn be beneficial for the whole village. Also, the building of the re-pumping station just outside Jaribuni has meant there is a possibility of bringing electricity to the village within the next few years.

5.0 The New Pipeline - supply to villages?

5.1 Cost

The pipeline water is metered at 5 cents (less than $\frac{1}{2}$ p) per debe (a metal container holding about 6 litres). The waterseller would charge 10 to 30 cts. per debe. The average consumption of water per household is 6 debes, and thus this price is not totally prohibitive.

5.2 Difficulties

1. At certain times of day there is no flow in the pipeline, due to the unfinished weir construction.
2. When many people are tapping water at the same time, the pressure reduction in the pipe slows the process of collection, and long queues may develop.
3. There are difficulties in the organisation of the villagers to construct standpipes, due to their general attitude to anything new. They are satisfied with their present supply, due to their ignorance of their dangers, and the benefits of the new supply.
4. Organisational difficulties are also a problem when attempting to advertise the standpipe as a profitable concern for an individual.
5. Connection costs of standpipes to pipeline (- materials).

Solutions

Basically more funds are needed to:-

- a) complete the weir construction and provide an adequate flow in the pipe.

b)

- b) and for materials to construct standpipes at every point needed.
- c) for official organisation of whom is in charge of each standpipe, and help to villages that could produce an harambee effort (perhaps in the form of a loan paid back by higher water prices).
- d) for education of the villagers, so that they can appreciate the benefits of the new supply, and hence will work to obtain it.
- e) for organisation of some form of fairer distribution along the pipeline, so that the rich hotels do not automatically assume a right to most of the water.

5.3 Standpipes

Connection points to the new supply are provided close to most of the towns and villages with the aim that standpipes and taps be connected in order to supply the communities.

At present, however, only the hotels and some of the larger towns possess standpipe connections. None of the smaller villages, including those of our study, have yet been connected.

This is partly a result of the scheme being, not yet, fully operational and partly because the local government do not have the funds to pay for the connections.

On a visit to the District Public Health Office at Kilifi we learned that an extensive survey had been recently carried out to determine - how many stand taps were required in each village and where, in the village, the stand taps should be placed. However, since the Department of Water does not intend to build the connections themselves, we wondered how the stand taps were to be built.

It seems that Department are hoping for a communal or "Harambee" effort by the villagers to purchase and lay the stand pipes themselves. There is also the possibility of an individual laying a standpipe and distributing water to the villagers himself, making a small profit for himself in the process.

Indeed in some small towns certain standpipe kiosks have been set up and with some degree of success. However, in one town, Majango, several kiosks were run inefficiently and their consequent closure caused a minor water crisis.

The setting up of standtaps on a harambee basis would seem to be the best and most feasible solution, although, much depends on the successful motivation of the villagers.

Certainly the provision of clean water from the new supply would be a

vast improvement in terms of health in comparison with the present systems of water supply.

Table 3 - Forecasted Standpipe connections

<u>Village</u>	<u>No. and Position of Standpipes Required</u>
Vipingo	5 - Towncentre, Health Centre, school, mission, Bureni
Kikambala	6 - Town centre, school, Amuneki, Gonejani
Gongoni	5 - school, dispensary, market, home-steads.

5.4 Conclusion

Whilst the problem of cost in the improvement of water supply and sanitation facilities is a major one, advances could certainly be made if an organized community effort is initiated.

The problem of organization, however, also falls heavily on the shoulders of the local governmental and health authorities. The communities do not understand the problems themselves, and thus, lack the necessary motivation to carry out self improvement schemes.

The enforcement of such improvements in the region is the job of the local Public Health education officer and his success largely depends on the level of acceptance of his proposals by the community. This level of acceptance is appreciably low at present due to the lack of understanding and appreciation of the problems of water supply and sanitation experienced by the community.

This lack of understanding is an educational one and is the major barrier facing any progress in the field of water supply and indeed in many other fields of development.

This is particularly true with regards the new pipeline since the villagers would need to be responsible for the maintenance and operation of standpipes and other appliances.

In conclusion, experience of conditions in all the villages we visited leads us to believe that the success of the new pipeline scheme in the

/villages

villages depends largely on the success of a simultaneous programme of education of the community on the need for clean water and hygiene and in the maintenance of new and old supplies. There is evidence of such programmes being carried out and if this trend expands and improves then the new pipeline will be successful in bringing a better standard of health and quality of life to the village people of this beautiful region.

A P P E N D I X

Diary of Events in Public Health Study

WEEK 1

5th - 10th Aug.

- (1) Nick and Becky travel to Mombasa and try and arrange accommodation
- (2) Thought is given to size of villages - scope of studies and possible contacts
- (3) Anne, Jenny and Niall arrive followed at the end of the week by Marek and Glenn, who had completed hydrological arrangements in Nairobi.

WEEK 2

10th - 17th Aug.

- (1) Permanent accommodation found in Cottage near Kikambala.
- (2) Brief visit made to Kilifi
- (3) Arrangements made for weekly meetings/progress reports, at the cottage, to be held each Friday evening whenever practical.
- (4) Niall and Nick establish contact with Public Health Education Officer, Mr. Ernest Mwandasa, and his students at the Vipingo District Health Centre.
- (5) Health Visit made at Vipingo - Niall and Nick shown around slaughter house and village health facilities including water wells. Shown around Vipingo Health Centre.
- (6) Niall and Jenny commence village study at Bureni.
- (7) Meetings arranged with Health Officers in Kilifi.

WEEK 3

18th - 24th Aug.

- (1) Meeting with District Commissioner of Kilifi - Becky, Anne and Nick. Purpose of Public Health study discussed, and greeted with interest and support by Commissioner.
- (2) Meeting with District Public Health Officer, at Kilifi Hospital - Jenny & Nick. Interesting discussion on regional health problems and to-date picture given of new pipeline.

WEEK 4

24th - 31st Aug.

- (3) Visit to Kilifi State School - Becky, Anne and Nick. Talk with Headmaster and several pupils about impact of new piped water supply on Kilifi.
- (4) Niall and Jenny complete Village Study at Bureni.
- (1) Public Health visit to Kikambala with Mr. Mwandasa - Nick and Jenny.
- (2) Preparations made for village study at Kikambala.
- (3) Nick and Becky commence Village Study at Kikambala
- (4) Nick and Becky meet with Elder of the village of Kikambala.
- (5) Glenn and Anne travel to Jaribuni and commence Village Study

WEEK 5

31st Aug. -
4th Sept.

- (1) Marek joins Nick on study of Kikambala
- (2) Questionnaire carried out in households of Kikambala.
- (3) Mapping of Kikambala carried out by Marek and Nick.
- (4) Glenn and Anne complete Village Study at Jaribuni.
- (5) Nick and Marek complete Village Study at Kikambala.

WEEK 6

4th - 10th Sept.

- (1) Becky and Niall map Bureni.
- (2) Loose ends tied up on village study projects.
- (3) Respects paid to all those in the villages who helped in the studies (e.g. Physics lessons given to Geoffrey).
- (4) Meeting held on return of those working at River.
- (5) Preparations made for departure from cottage.

Diagram 1 - Typical Structures in Village

Mwarangombe

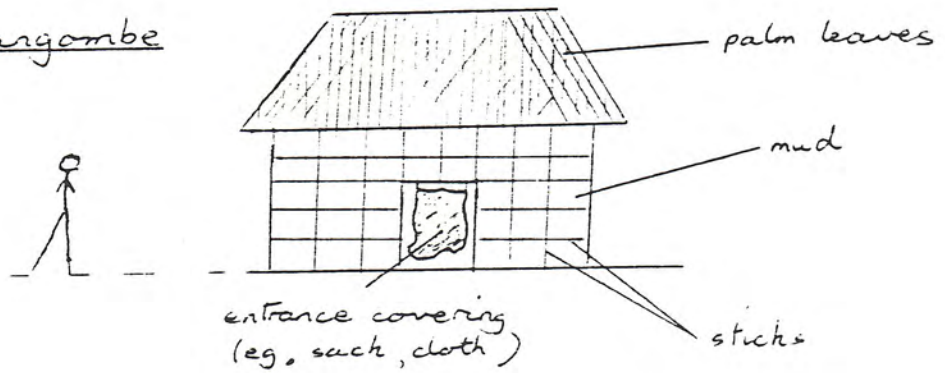

Majanni



Kitchen

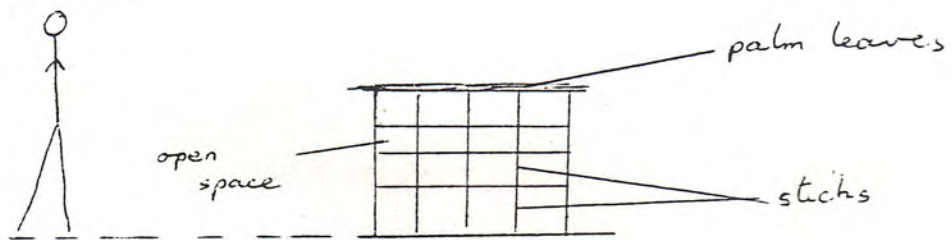

Boma

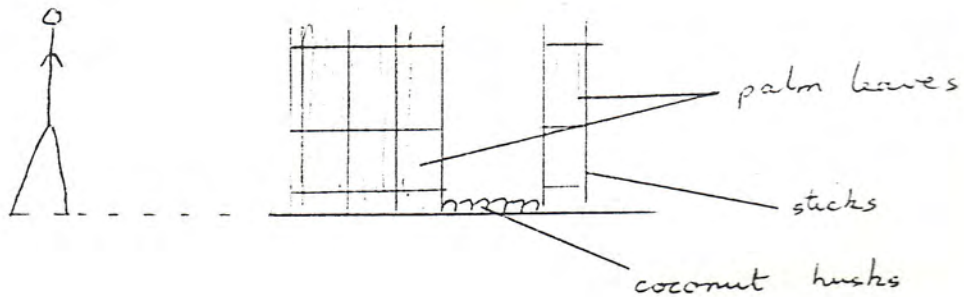
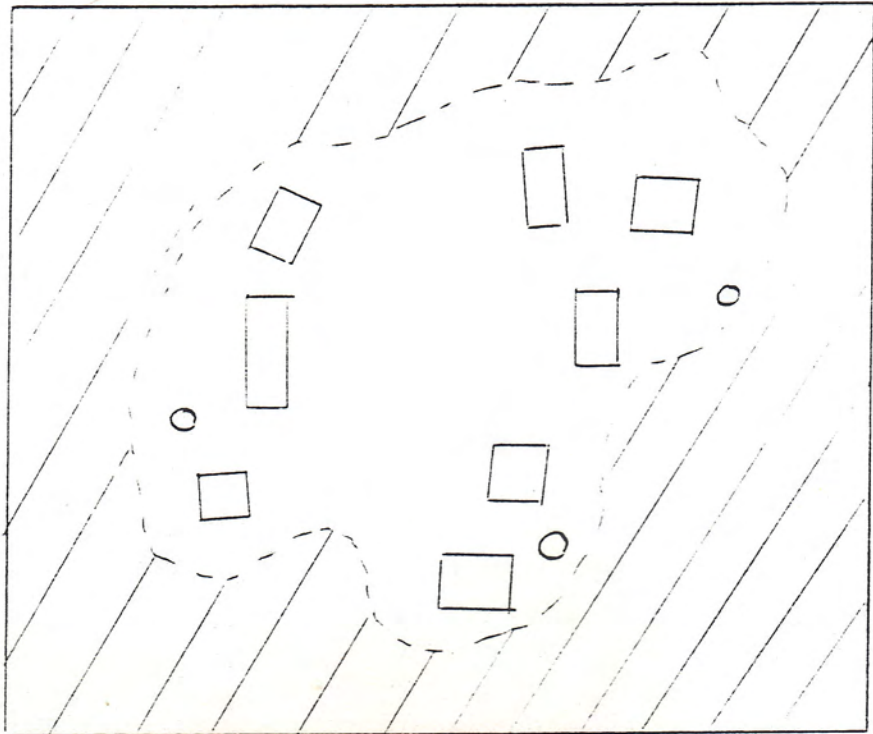

Diagram 2 - Typical Compound



KEY

□ = house

○ = boma

// = shambas

○ = bare earth

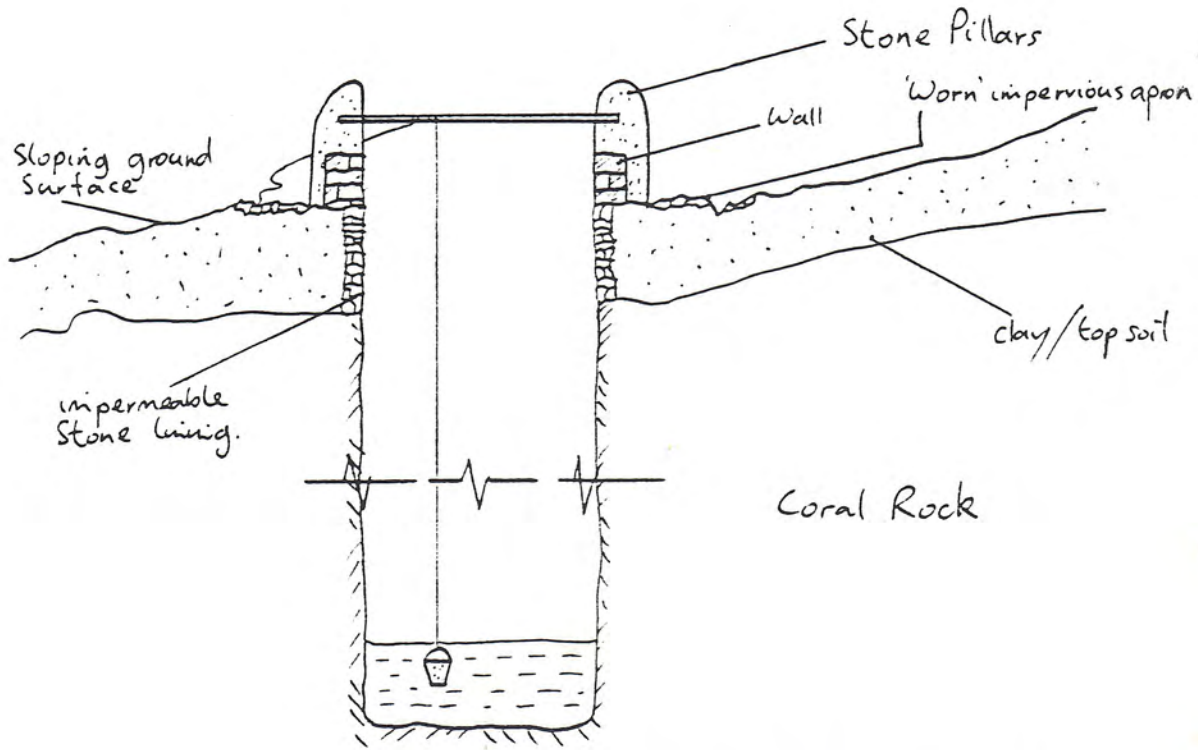

Diag. 3 Typical Hand Dug Well. (not to Scale)

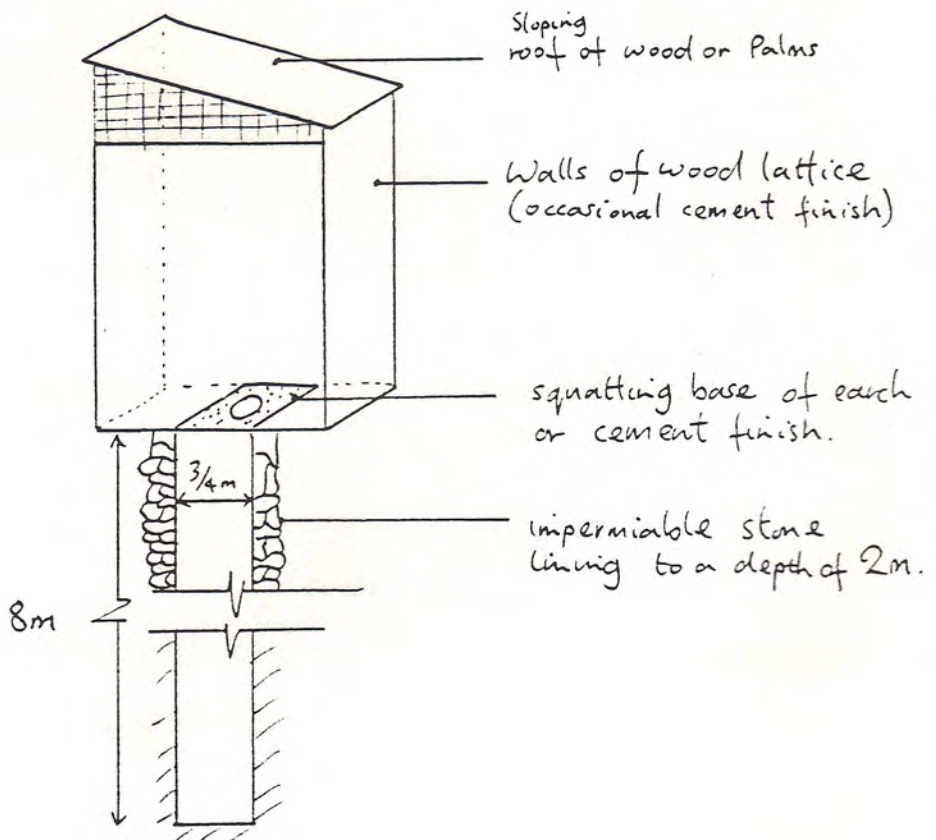

Diag. 4. Ideal Pit Latrine

Water crisis hits Majengo

By NATION Reporter
AN acute water shortage has hit hundreds of residents at Majengo following closure of two water kiosks.

The kiosks at Mwembe-Tanganyika and Buraya were closed 10 days ago. Residents now crowd at Sidiria Kiosk which is unable to cope with the demand.

A resident of Guraya, Mr. Mohammed Sheikh, complained that the decision to close the kiosks made them "live beyond their livelihood".

Residents are also forced to buy water from handcart hawkers at exorbitant prices: a tin goes to between /35 and /40. Under normal circumstances, a tin of water costs /25.

Water Department officials

have remained tight-lipped over the issue. When contacted, the general manager for Coast, Mr. O.S. Cege, said he had no idea about the kiosk closure.

Referring the NATION to one of his inspectors, Mr. Cege said: "The matter has not been brought to my attention. But it could be something internal."

And water Insp. C. Khasamba declined to talk, saying he was not use Mr. Cege wanted him to speak to the Press.

But pressed by the NATION, he admitted the kiosks were closed. He argued that they did not affect over 20,000 consumers.

"But do bring me their account numbers. Then I would be in a position to tell you the reason," he said.

Other sources indicated the kiosks might have had their

meters disconnected as a result of non-payment of bills.

A resident told the NATION that when a water official was contacted, he declined to explain the reason for the closure except saying: "The matter is being sorted out at the headquarters. I cannot commit myself to anything."

The official is reported to have asked the resident to be patient and the matter would be finalised in a day or two.

Meanwhile, it has been reported that the recent rationing of water in Mombasa between 6 p.m. and 6 a.m. will be relaxed today.

Supply to Mombasa was disrupted after a section of the Sabaki pipeline was washed away by floods in Kilifi.

Dig 5.

Article from "NATION" (24th April 1981)